

S7686

## Photodiode with sensitivity close to spectral luminous efficiency

S7686 is a Si photodiode having a spectral response characteristic that is more similar to the human eye sensitivity (spectral luminous efficiency) than our conventional visible-compensated sensors (S1133, etc.).

### Features

- Spectral response analogous to CIE spectral luminous efficiency  
Spectral response range: 480 to 660 nm  
Peak sensitivity wavelength: 550 nm
- Ceramic package for reliability
- Active area: 2.4 × 2.8 mm
- High-speed response: 0.5 μs (VR=0 V, RL=1 kΩ)
- fs value: 8 % Typ. (vertical light input)

### Applications

- Illuminometer
- Luminance meter

### Absolute maximum ratings (Ta=25 °C)

Parameter	Symbol	Condition	Value	Unit
Reverse voltage	VR Max.		10	V
Operating temperature	Topr	No dew condensation*1	-10 to +60	°C
Storage temperature	Tstg	No dew condensation*1	-20 to +70	°C

\*1: When there is a temperature difference between a product and the surrounding area in high humidity environment, dew condensation may occur on the product surface. Dew condensation on the product may cause deterioration in characteristics and reliability.

Note: Exceeding the absolute maximum ratings even momentarily may cause a drop in product quality. Always be sure to use the product within the absolute maximum ratings.

### Electrical and optical characteristics (Ta=25 °C)

Parameter	Symbol	Condition	Min.	Typ.	Max.	Unit
Spectral response range	$\lambda$		-	480 to 660	-	nm
Peak sensitivity wavelength	$\lambda_p$		-	550	-	nm
Photo sensitivity	S	$\lambda = \lambda_p$	-	0.38	-	A/W
Short circuit current	Isc	100 lx, 2856 K	-	0.45	-	μA
Dark current	ID	VR=1 V	-	2	20	pA
Rise time	tr	VR=0 V, RL=1 kΩ	-	0.5	-	μs
Terminal capacitance	Ct	VR=0 V, f=10 kHz	-	200	-	pF

**Spectral response**

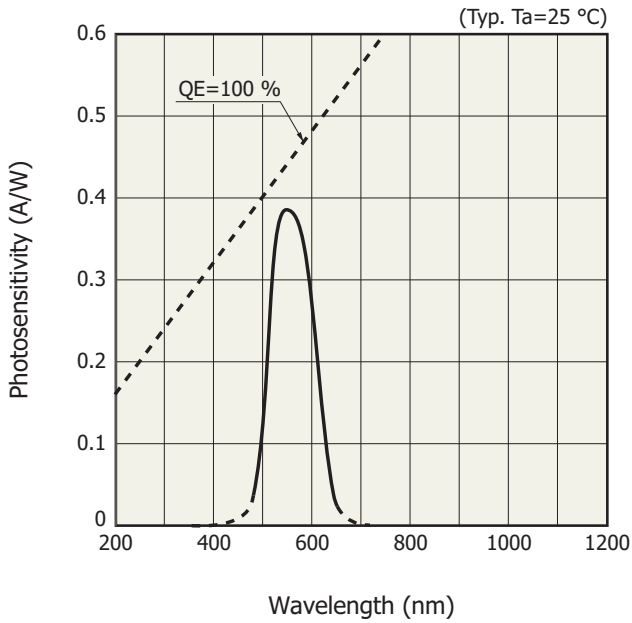

KSPDB0133EC

**Spectral response (relative value)**

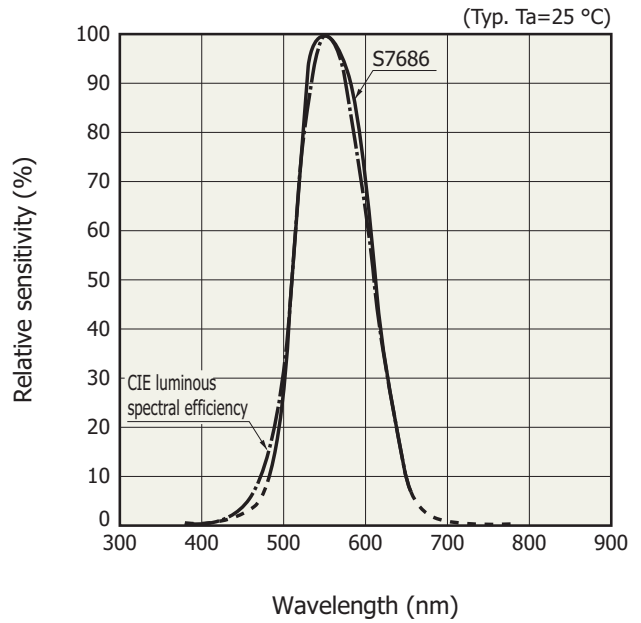

KSPDB0092EC

**Linearity**

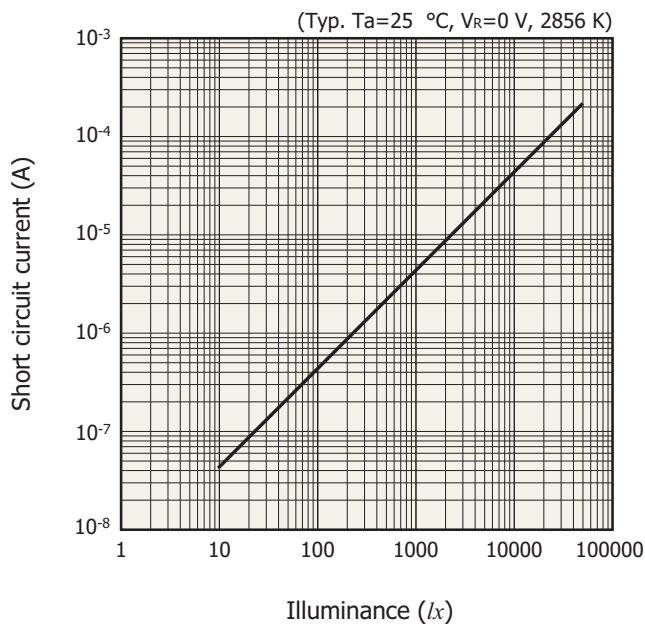

KSPDB0341EA

**Dark current vs. reverse voltage**

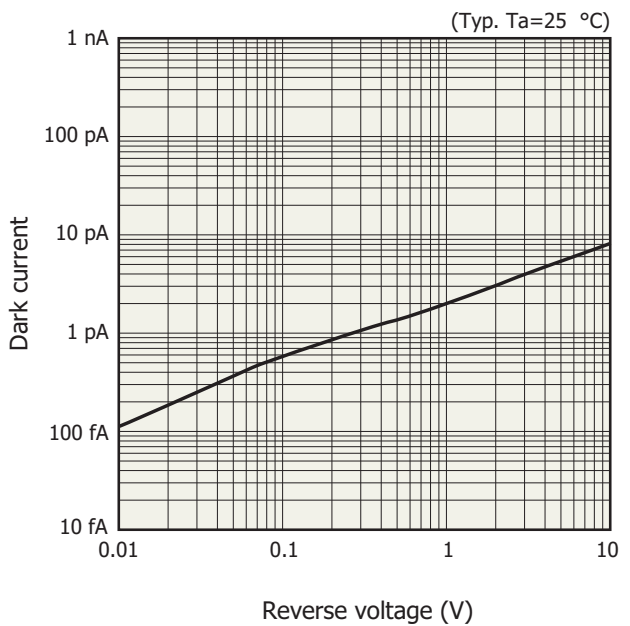

KSPDB0144EA

**Terminal capacitance vs. reverse voltage**

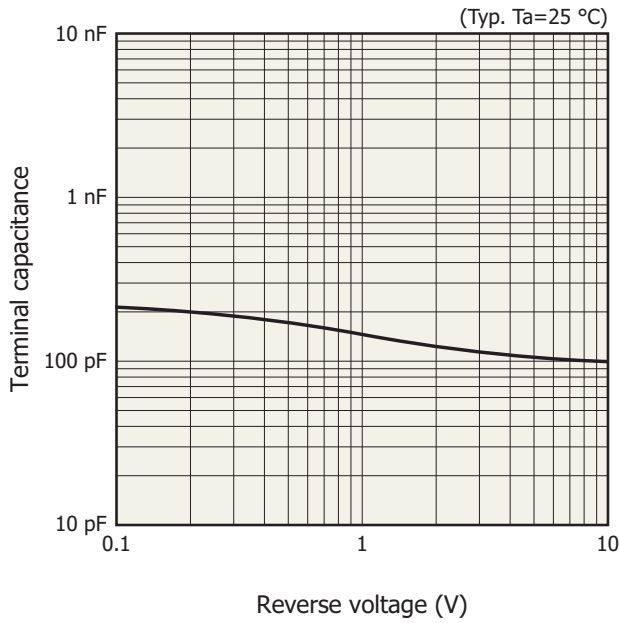

KSPDB0145EA

**Directivity**

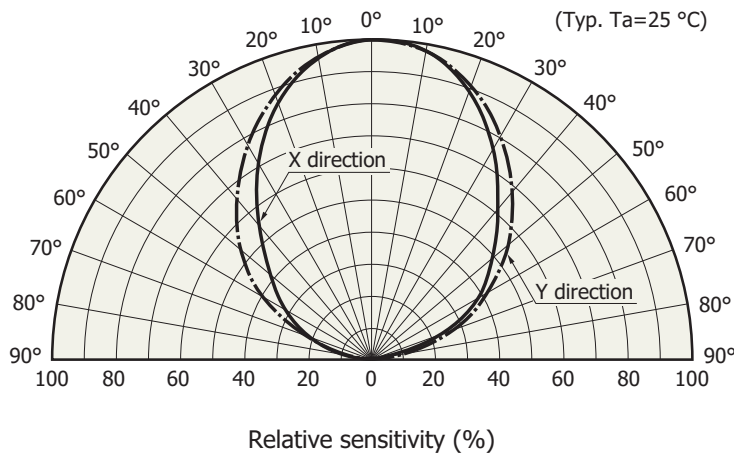

KSPDB0339EA

**Dimensional outline (unit: mm, tolerance unless otherwise noted: ±0.15)**

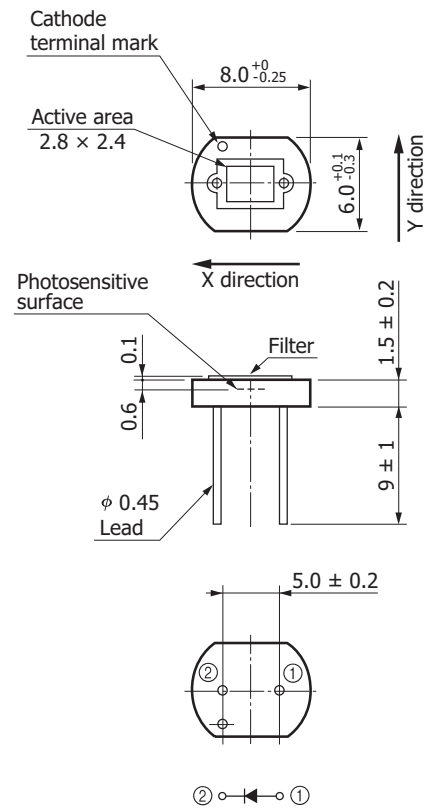

KSPDA0089EB

## Related information

[www.hamamatsu.com/sp/ssd/doc\\_en.html](http://www.hamamatsu.com/sp/ssd/doc_en.html)

### ■ Precautions

- Disclaimer
- Metal, ceramic, plastic products / Precautions

### ■ Technical information

- Si photodiode / Application circuit examples

Information described in this material is current as of April, 2016.

Product specifications are subject to change without prior notice due to improvements or other reasons. This document has been carefully prepared and the information contained is believed to be accurate. In rare cases, however, there may be inaccuracies such as text errors. Before using these products, always contact us for the delivery specification sheet to check the latest specifications.

The product warranty is valid for one year after delivery and is limited to product repair or replacement for defects discovered and reported to us within that one year period. However, even if within the warranty period we accept absolutely no liability for any loss caused by natural disasters or improper product use. Copying or reprinting the contents described in this material in whole or in part is prohibited without our prior permission.

# HAMAMATSU

[www.hamamatsu.com](http://www.hamamatsu.com)

HAMAMATSU PHOTONICS K.K., Solid State Division

1126-1 Ichino-cho, Higashi-ku, Hamamatsu City, 435-8558 Japan, Telephone: (81) 53-434-3311, Fax: (81) 53-434-5184

U.S.A.: Hamamatsu Corporation: 360 Foothill Road, Bridgewater, N.J. 08807, U.S.A., Telephone: (1) 908-231-0960, Fax: (1) 908-231-1218

Germany: Hamamatsu Photonics Deutschland GmbH: Arzbergerstr. 10, D-82211 Herrsching am Ammersee, Germany, Telephone: (49) 8152-375-0, Fax: (49) 8152-265-8

France: Hamamatsu Photonics France S.A.R.L.: 19, Rue du Saule Trapu, Parc du Moulin de Massy, 91882 Massy Cedex, France, Telephone: 33-(1) 69 53 71 00, Fax: 33-(1) 69 53 71 10

United Kingdom: Hamamatsu Photonics UK Limited: 2 Howard Court, 10 Tewin Road, Welwyn Garden City, Hertfordshire AL7 1BW, United Kingdom, Telephone: (44) 1707-294888, Fax: (44) 1707-325777

North Europe: Hamamatsu Photonics Norden AB: Torshamnsgatan 35 16440 Kista, Sweden, Telephone: (46) 8-509-031-00, Fax: (46) 8-509-031-01

Italy: Hamamatsu Photonics Italia S.r.l.: Strada della Moia, 1 int. 6, 20020 Arese (Milano), Italy, Telephone: (39) 02-93581733, Fax: (39) 02-93581741

China: Hamamatsu Photonics (China) Co., Ltd.: B1201, Jiaming Center, No.27 Dongsanhuan Bellu, Chaoyang District, Beijing 100020, China, Telephone: (86) 10-6586-6006, Fax: (86) 10-6586-2866