

860nm 1W Multimode Laser Diode

Part Number		WSLD-860-001-2-PD		
PARAMETER	SYMBOL	VALUE	UNIT OF MEASURE	
Reverse Voltage	V_r	2.0	V	
Operating Temperature	T_{op}	0~+40	°C	
Storage Temperature	T_{stg}	-40~+85	°C	
Lead Soldering Temperature (10 sec.)	T_{is}	260	°C	
Typical Specification (@25°C)		Min.	Typical Value	Max.
Optical Parameters	Center Wavelength	860nm+/-10nm		
	Output Power	----	1.0W	----
	Spectral Width(FWHM)	----	2.0nm	----
	Wavelength Temp. Coefficient	0.3nm/°C		
	Laser Type	FP		
	Beam Type	Multimode		
	Emitter Size	100um x 1um		
	Beam Divergence (FWHM)	----	38°±x10°//	40°±x12°//
Electrical Parameters	Threshold Current	----	0.2A	----
	Operating Current	----	1.3A	----
	Operating Voltage	----	2.5V	----
Photodiode Parameters	Photodiode	Built-in		
	PD Current	----	0.1mA	----
	PD Reverse Voltage (Max.)	30V		
Other Parameters	Package	TO5 (9mm)		
	Recommended Operating Temp.	25°C		

Product Package View:

TO5 (9mm) Package:

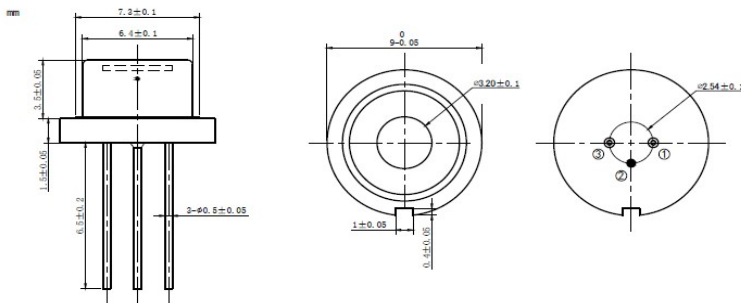

PIN Bottom View:

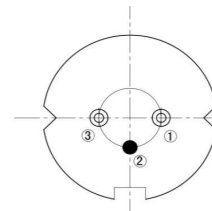

Pin-1	LD(-)
Pin-2	LD(+)&PD(-),CASE
Pin-3	PD(+)