

Technical Information

Xenon Flash Lamps



Xenon Flash Lamps

Xenon flash lamps are pulsed light sources that emit light with an instantaneous high peak output. Xenon flash lamps offer great features such as small size, low heat generation, easy handling, and a continuous spectrum from the UV to infrared region (160 nm to 7500 nm), making these lamps useful in a wide range of applications including chemical analysis and imaging.

Hamamatsu provides high-quality, high-precision xenon flash lamps. Peripheral devices such as specially designed trigger sockets and power supplies as well as easy-to-use lamp modules integrated with those devices are also available to extract maximum performance from xenon flash lamps.



1/ Structure	P04
1-1 Anode and cathode	
1-2 Trigger probe	
1-3 Sparker	
1-4 Light output window	
2/ Operation	P06
2-1 Principle	
2-2 Circuit configuration	
3/ Characteristics	P07
3-1 Emission pulse waveform	
3-2 Delay time and time fluctuations (Jitter time)	
3-3 Main discharge current	
3-4 Spectral distribution	
3-5 Brightness characteristics	
3-6 Directivity (Light distribution)	
3-7 Lamp input energy	
3-8 Light output stability	
3-9 Approach to stabilizing the light output	
4/ Life	P19
5/ Electromagnetic noise	P20
6/ Trigger sockets	P21
6-1 Structure	
6-2 Operation	
7/ Power supplies	P22
7-1 Main discharge power supply	
7-2 Trigger power supply	
7-3 Power supply design precautions	
8/ Applications	P24
8-1 Water quality analysis	
8-2 Atmospheric analysis and gas analysis	
8-3 Mineral and gemstone inspection	
8-4 Color analysis	
8-5 Semiconductor inspection and process control	
8-6 Food inspection	
8-7 In vitro diagnostics (Blood and urine)	
8-8 UV to visible spectrophotometry	
8-9 High-performance liquid chromatography (HPLC)	
8-10 MTP reader	
8-11 Imaging flow cytometry	

1 Structure

Xenon flash lamps are filled with a high-purity xenon gas in a small enclosure made of glass or metal that contains an anode, a cathode, trigger probes and a sparker. Xenon flash lamp modules consist of a xenon flash lamp and peripheral devices such as a trigger socket and a power supply, all integrated into a compact metal housing.



1-1 Anode and cathode

The anode and cathode of xenon flash lamps are electrodes uniquely designed to exhibit outstanding features such as high electron emission capability, low operating temperature, and less electrode wear. The anode and cathode have conical shapes facing each other that are designed to concentrate an electric field between their tips to generate stable light emission. The anode to cathode distance is referred to as the arc size, and an arc discharge is formed according to this distance.

■ Figure 1: Internal structure

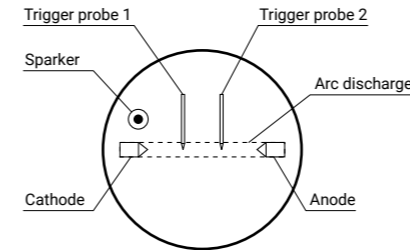

■ Figure 2: Electrode shape

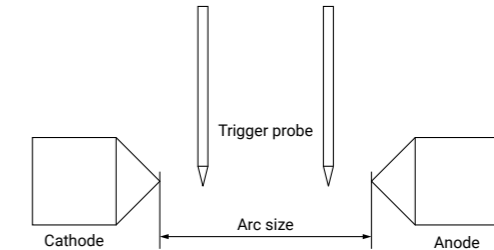

1-2 Trigger probe

Trigger probes are electrodes that trigger stable light emission. These electrodes have a needle-like shape designed to concentrate an electric field at their tip. The number of trigger probes differs depending on the arc size.

1-3 Sparker

The sparker is an electrode to ensure light emission of the xenon flash lamp.

1-4 Light output window

The spectral emission range of xenon flash lamps differs according to the window material.

■ Table 1: Spectral transmission range of window materials

Window material	Spectral transmission range (nm)
UV glass	185 to 2500
Borosilicate glass	240 to 2500
Sapphire glass	190 to 5000
MgF ₂	160 to 7500

■ Figure 3: Transmittance of window materials (Typ.)

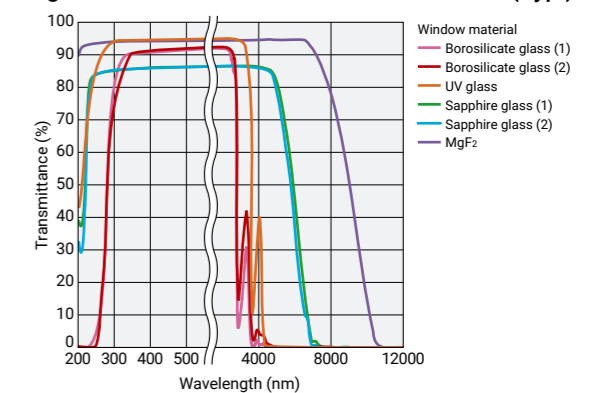

2 Operation

2-1 Principle

Xenon flash lamps generate light emission by way of a discharge between the anode and cathode, known as the main discharge. There is also a series of a preliminary discharge which enable the generation of a stable main discharge. Preliminary discharge is produced by a spike-like voltage called the trigger voltage that is applied to each electrode: the cathode, sparker, trigger probes, and anode.

Xenon flash lamps emit light in synchronization with a trigger signal. When a trigger signal is input, the trigger voltage is applied to each electrode, and at the same time the sparker generates a discharge to emit UV radiation. This UV radiation strikes each electrode releasing photoelectrons which ionize the high-purity xenon gas inside the lamp. A discharge occurs between each trigger probe to form the preliminary discharge. Immediately after this process, the main discharge takes place between the anode and cathode along the preliminary discharge path.

■ Figure 4: Flash operation (Arc size: 3.0 mm)

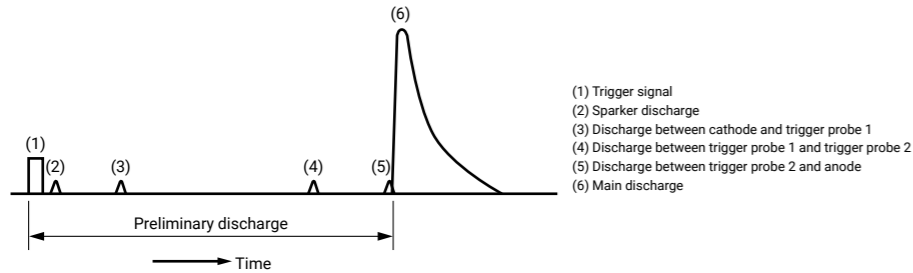

There is a certain time interval between the input of a trigger signal and the emission of light. This time interval varies depending on the arc size (number of trigger probes) and filler gas pressure, etc.

2-2 Circuit configuration

A xenon flash lamp is operated in combination with a trigger socket and a power supply as shown in the circuit diagram below. Our xenon flash lamp modules include all of these components in a compact housing.

■ Figure 5: Circuit configuration example

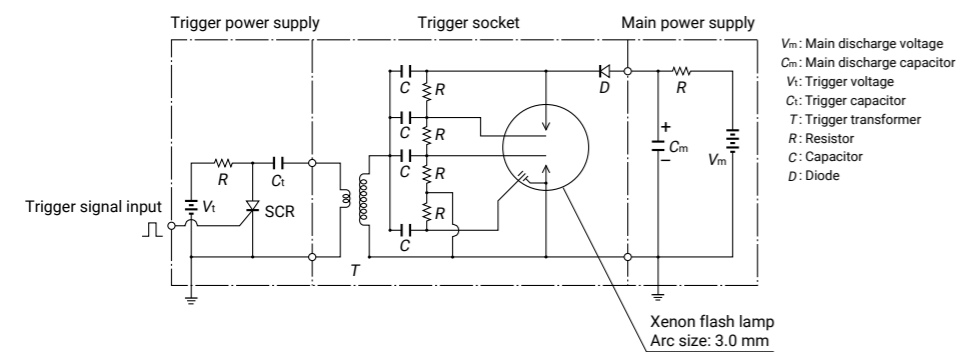

Xenon flash lamps



Trigger sockets



Power supplies



Xenon flash lamp modules

3 Characteristics

3-1 Emission pulse waveform

The emission pulse waveform of a xenon flash lamp is determined by the arc size, main discharge voltage, main discharge capacitance, and the inductance (trigger socket cable length, etc.) between the xenon flash lamp and the main discharge capacitor.

(1) Emission pulse waveforms at different arc sizes

Wider pulse duration and higher output can be obtained with the longer arc size. In contrast, the brightness becomes higher with the shorter arc size.

■ Figure 6: Emission pulse waveform (Typ.)

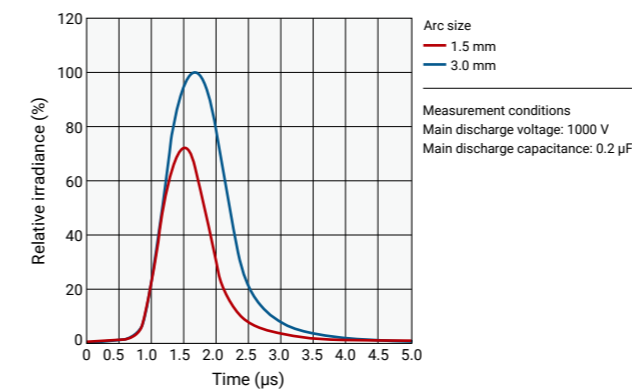

■ Figure 7: Brightness characteristics (Typ.)

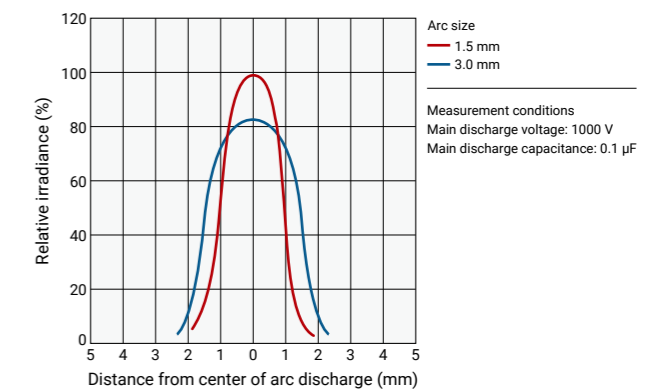

(2) Emission pulse waveforms at different main discharge capacitances

The larger the main discharge capacitance is, the higher the maximum lamp input energy and the light output get with a wider flash pulse width (longer flash duration).

■ Figure 8: Emission pulse waveform (Typ.)

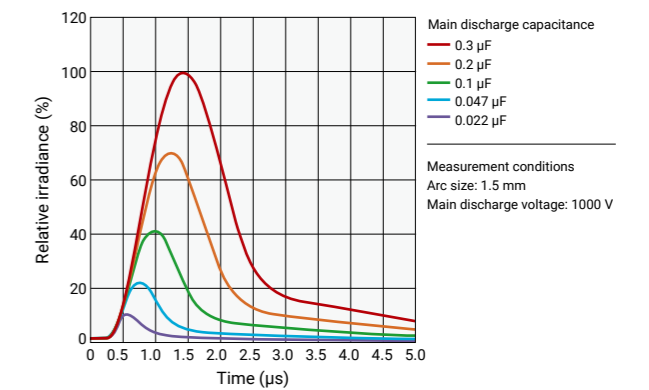

(3) Emission pulse waveforms at different main discharge voltages

The maximum lamp input energy and the light output get higher with the higher main discharge voltage. The flash pulse width (flash duration) remains unchanged, unlike the case with the main discharge capacitance.

■ Figure 9: Emission pulse waveform (Typ.)

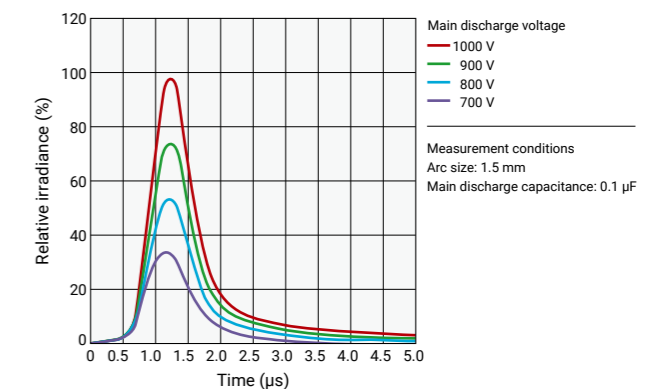

3 Characteristics

(4) Emission pulse waveforms at different inductances

The emission pulse waveform varies with the inductance (cable length of trigger socket, etc.) between the xenon flash lamp and the main discharge capacitance.

■ Figure 10: Emission pulse waveform (Typ.)

·At different cable lengths of trigger socket

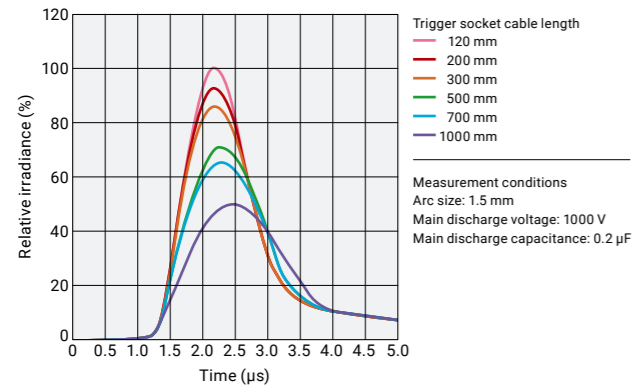

■ Figure 11: Emission pulse waveform (Typ.)

·Waveforms for coils of different inductances placed between xenon flash lamp and main discharge capacitor

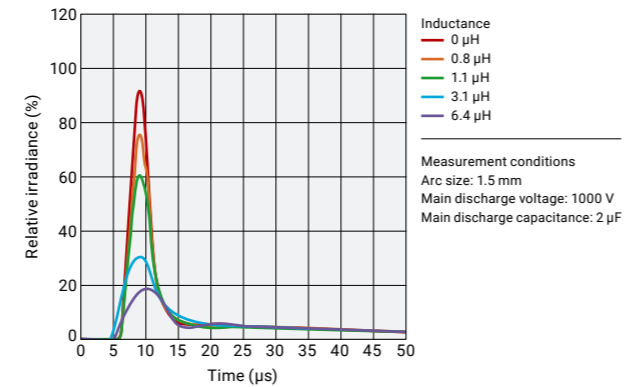

To shorten the flash pulse width (flash duration), the inductance should be reduced as much as possible. It can be reduced by shortening the cable between the xenon flash lamp and the main discharge capacitor or by connecting the main discharge capacitor directly to the xenon flash lamp. When the main discharge capacitor (0.01 μF) is connected directly to the xenon flash lamp, the flash pulse width (FWHM) will be approx. 150 ns.

■ Figure 12: Emission pulse waveform (Typ.)

·When main discharge capacitor (0.01 μF) is directly connected to xenon flash lamp

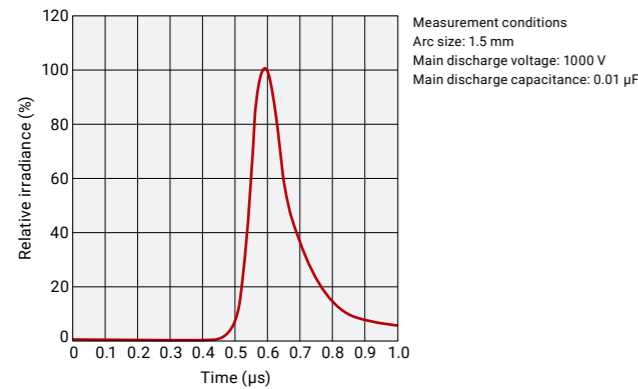

Measurement setup

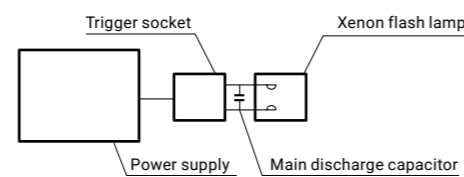

NOTE: The main discharge capacitor is not built into the power supply.

(5) Flash duration and deionization time

The xenon flash lamps emit a flash of light by ionizing the high-purity filled xenon gas, so the time taken for the light to extinguish varies depending on the lamp input energy, etc. For example, if the deionization time of a xenon flash lamp is approx. 400 μs, then the time taken for the light to extinguish will be approx. 30 μs.

■ Figure 13: Flash pulse fall time (Typ.)

·5 W xenon flash lamp module (L9455-01)

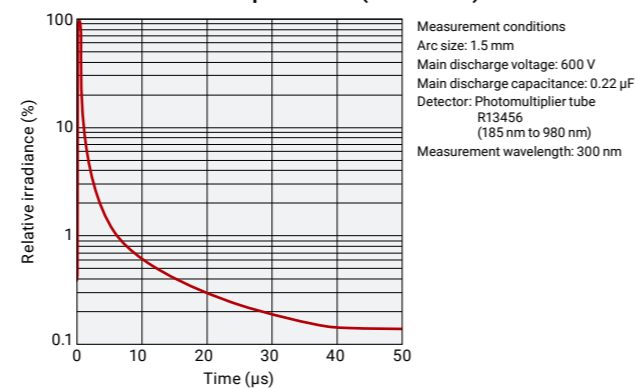

3-2 Delay time and time fluctuations (Jitter time)

The main discharge flash occurs a few microseconds after a trigger signal is input (delay time). The timing of each light flash is also subject to fluctuations of several hundred nanoseconds (jitter time). The delay time and jitter time differ depending on the preliminary discharge period and main discharge voltage for the xenon flash lamp and also the trigger system components of the power supply (photocoupler and thyristor response time, etc.). To take these characteristics into account, high-precision measurements require a method that allows setting the signal acquisition time to match the timing of each light flash (for example by opening the gate of the A/D converter).

■ Figure 14: Flash operation

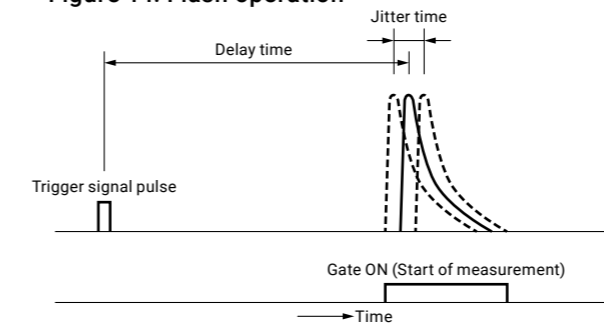

3-3 Main discharge current

When a xenon flash lamp is operated with a main discharge voltage of 1000 V and a main discharge capacitance of 0.1 μF, a peak current of more than 400 A will flow in the lamp. A diode is therefore connected to the anode to suppress possible ringing and prevent failures in the power supply, thus increasing the lamp's light emission performance.

■ Figure 15: Main discharge current waveform (Typ.)

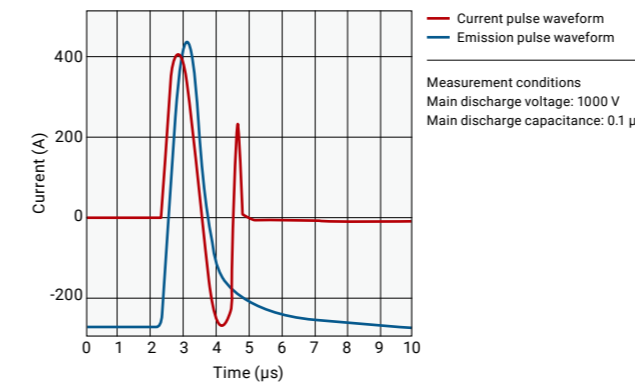

Measurement setup

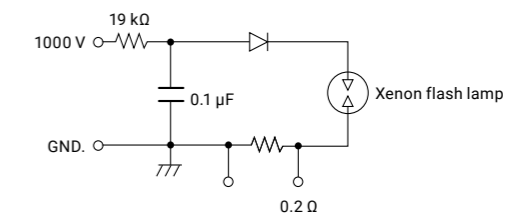

3 Characteristics

3-4 Spectral distribution

Xenon flash lamps emit a continuous spectrum ranging from the UV to infrared region (160 nm to 7500 nm) and containing line spectra specific to xenon gas. This spectrum varies according to the filler gas pressure and lamp input energy. It will also differ depending on the transmittance of the window material.

■ Figure 16: Spectral distribution (Typ.)

•UV region of 20 W xenon flash lamp

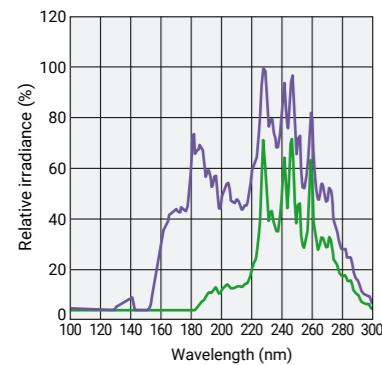

— UV glass
— MgF₂

Measurement conditions
Under nitrogen atmosphere

■ Figure 17: Spectral distribution (Typ.)

•Visible region of 20 W xenon flash lamp

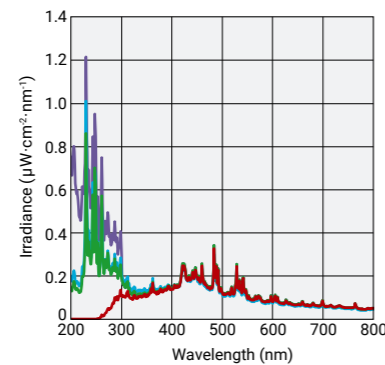

— Borosilicate glass (L11936)
— UV glass (L11937)
— Sapphire glass (L11938)
— MgF₂(L14691)

Measurement conditions
Main discharge voltage: 1000 V
Main discharge capacitance: 1.0 μF
Repetition rate: 40 Hz
Detector: Si photodiode
(200 nm to 800 nm, Spectral bandwidth 1 nm)
Measurement distance: 500 mm

■ Figure 18: Spectral distribution (Typ.)

•Infrared region of 20 W xenon flash lamp

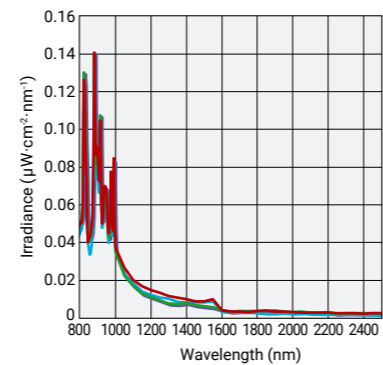

— Borosilicate glass (L11936)
— UV glass (L11937)
— Sapphire glass (L11938)
— MgF₂(L14691)

Measurement conditions
Main discharge voltage: 1000 V
Main discharge capacitance: 1.0 μF
Repetition rate: 40 Hz
Detector: Si-InGaAs photodiode
(200 nm to 800 nm, Spectral bandwidth 1 nm)
InGaAs photodiode
(1600 nm to 2500 nm, Spectral bandwidth 5 nm)
Measurement distance: 500 mm

The spectral distribution of xenon flash lamps depends largely on the current density of the lamp. The intensity in the infrared region increases when the current is low, while the intensity in the UV region increases when the current is high. The peak lamp current and main discharge voltage have a proportional relationship shown by the following equations.

■ Average lamp current

$$I_{rms} = \frac{C_m V_m}{\sqrt{t} 1/3 / f} = C_m V_m \sqrt{\frac{t}{t 1/3}}$$

■ Peak lamp current

$$I_{pk} = V_m \sqrt{C_m / L} = \frac{\pi C_m V_m}{t 1/3}$$

C_m: Main discharge capacitance
V_m: Main discharge voltage
1/f: Rate
 $t 1/3 = \pi \sqrt{LC_m}$ = Current 1/3 pulse width
 $L = \frac{1}{\pi^2 f^2 C_m}$: 0.5 μH (Circuit inductance)

■ Figure 19: Spectral distribution (Typ.)

•At different main discharge voltages with fixed main discharge capacitance (0.1 μF)

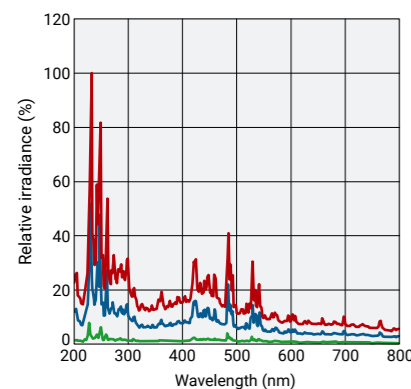

Main discharge voltage (V)	Lamp input energy (mJ)
1000	50.0
700	24.0
300	4.5

3-5 Brightness characteristics

The brightness of xenon flash lamps differs depending on the arc size. The shorter the arc size, the higher the brightness. In contrast, the longer the arc size, the higher the total radiant intensity.

■ Figure 20: Brightness characteristics (Typ.)

•Measurement line A

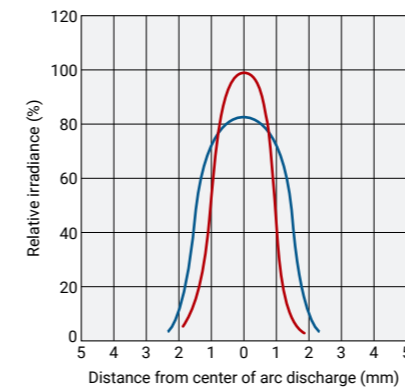

•Measurement line B

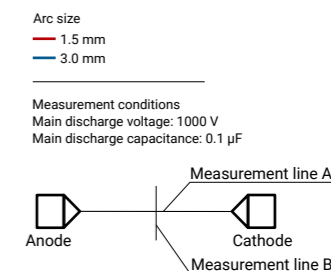
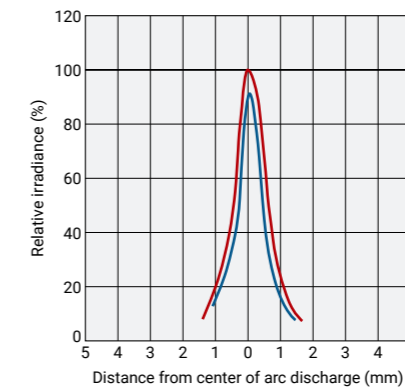

The light output stability of xenon flash lamps differs depending on the position in the arc discharge. The highest brightness is obtained at the center of an arc discharge, and this holds true for the brightness stability which is also highest at the center of an arc discharge. In applications where high stability is required, we recommend using light emitted only from the center of an arc discharge. For example, when focusing light into an optical fiber or small slit or aperture using optical components such as convex lenses or concave mirrors.

■ Figure 21: Brightness stability (Typ.)

•Measurement line A

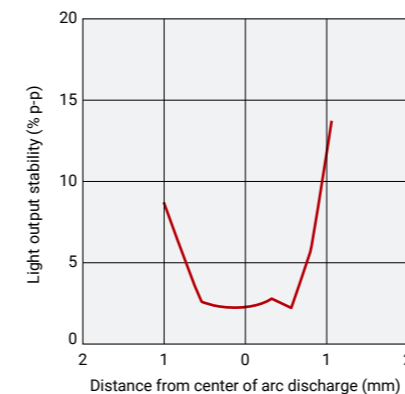

•Measurement line B

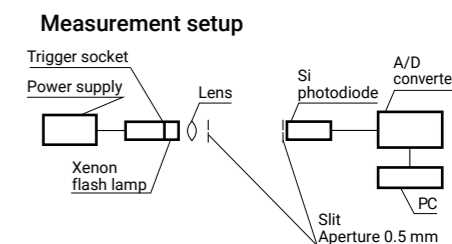
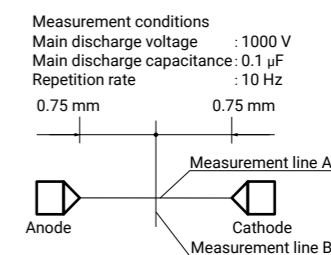
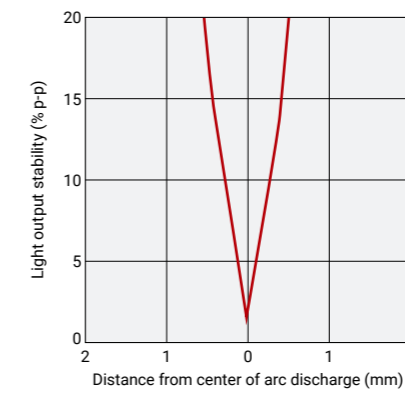

■ Figure 22: Example of focusing the emitted light

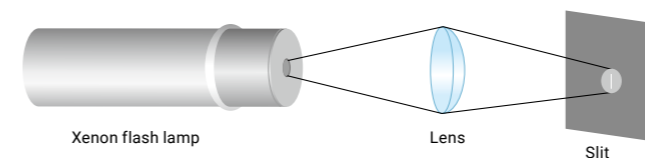

3 Characteristics

3-6 Directivity (Light distribution)

The directivity depends on the lamp bulb shape and arc size and does not depend on the window material.

■ Directivity (Typ.)

•Figure 23: 2 W xenon flash lamp module (L13651-01)

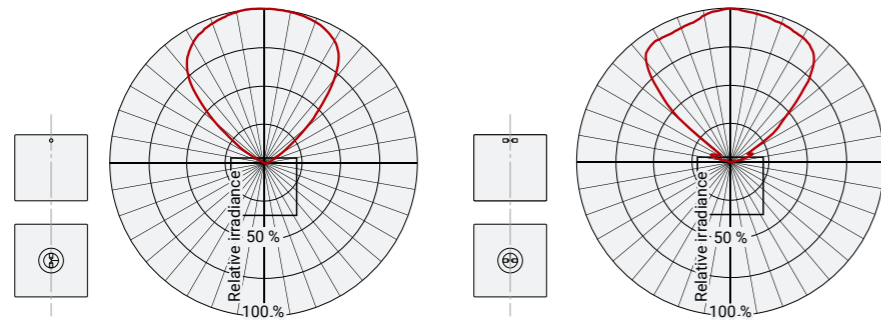

Measurement conditions
Main discharge voltage: 600 V
Main discharge capacitance: 0.141 μ F
Repetition rate: 79 Hz
Detector: Phototube R765 (160 nm to 320 nm)
Measurement distance: 500 mm

•Figure 24: 5 W xenon flash lamp module

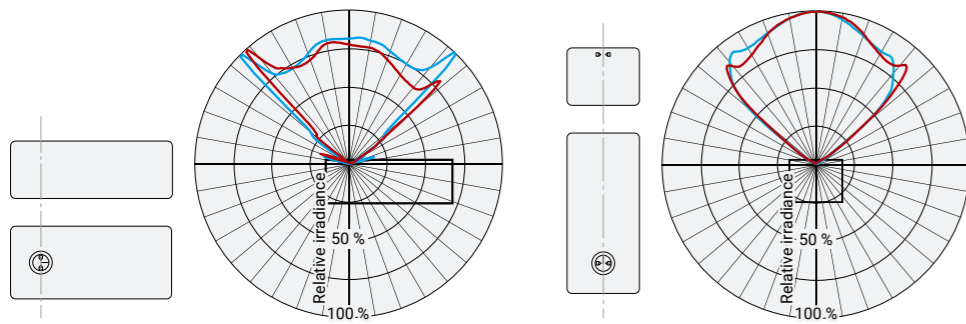

— Arc size 1.5 mm (L9455-01)
— Arc size 3.0 mm (L9456-01)
Measurement conditions
Main discharge voltage: 600 V
Main discharge capacitance: 0.22 μ F
Repetition rate: 126 Hz
Detector: Phototube R765 (160 nm to 320 nm)
Measurement distance: 500 mm

•Figure 25: 10 W xenon flash lamp

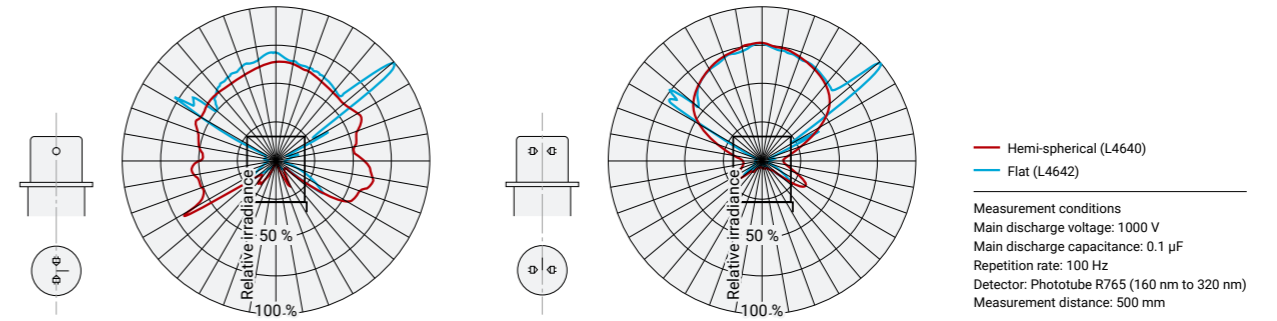

•Figure 26: 15 W xenon flash lamp

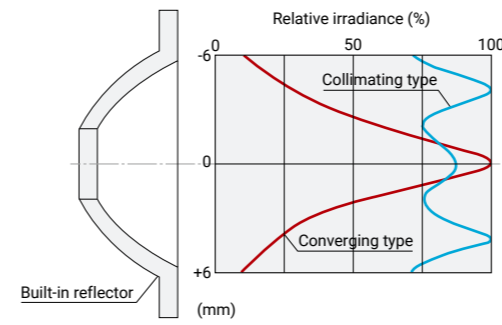

Measurement method

The directivity of the converging type with a built-in reflector is measured by placing an opal glass plate at the light converging position of the reflector. For the collimating type, it is measured by placing an opal glass plate at a position 10 mm away from the lamp.

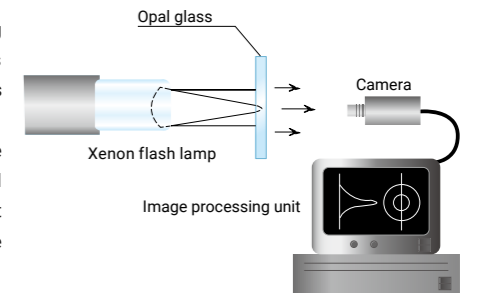

•Figure 27: 20 W xenon flash lamp and 20 W xenon flash lamp module

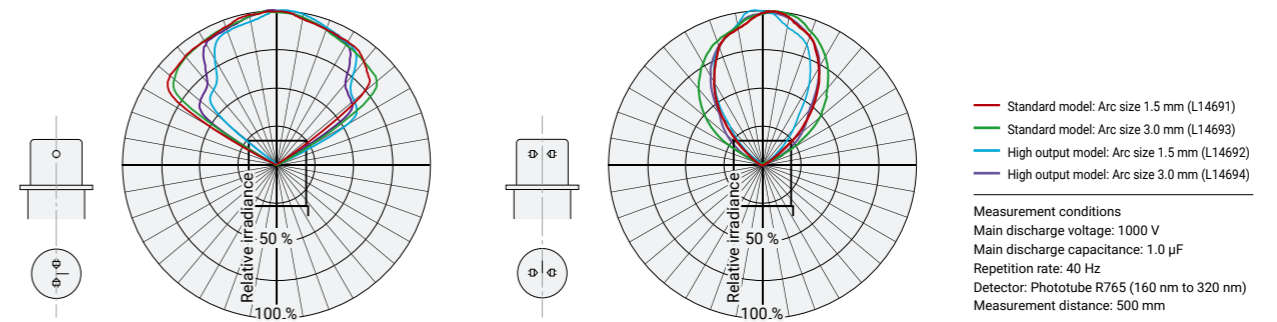

•Figure 28: 60 W xenon flash lamp

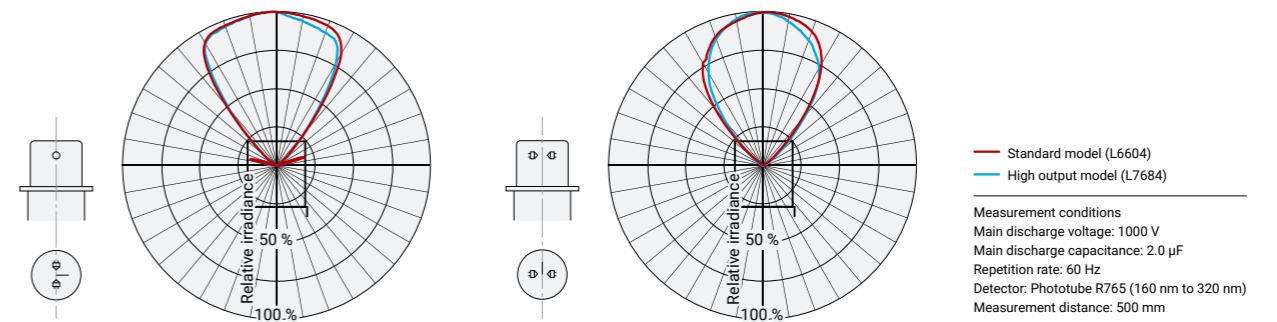

3 Characteristics

3-7 Lamp input energy

The light output of xenon flash lamps is proportional to the lamp input energy. To obtain highly stable light pulses, Hamamatsu specifies the input energy for each lamp. The maximum lamp input energy (per flash) and maximum repetition rate are given by the following equations.

$$E = 1/2 \times C_m \times V_m^2$$

E: Lamp input energy (per flash) (J)
P: Average lamp input (continuous) (W)
C_m: Main discharge capacitance (F)
V_m: Main discharge voltage (V)
f: Repetition rate (Hz)

$$P = E \times f$$

For example, when operating a 20 W xenon flash lamp at a main discharge voltage of 1000 V using a recommended power supply C13316-10 [main discharge capacitance: 1.0 μF (10⁻⁶ F)], the maximum lamp input energy (per flash) is 0.5 J as calculated by the following equation:

$$E = 1/2 \times 10^{-6}(\text{F}) \times 1000(\text{V})^2 = 0.5(\text{J})$$

In the above case, the maximum repetition rate of the 20 W xenon flash lamp is 40 Hz as calculated by the following equation:

$$f = 20(\text{W}) / 0.5(\text{J}) = 40(\text{Hz})$$

When selecting a lamp, the maximum lamp input energy and maximum repetition rate must be taken into account so that the maximum average lamp input (continuous) will not exceed the rating.

The graphs below show the average lamp current and peak lamp current plotted by changing the main discharge capacitance.

■ Figure 29: Average lamp current (Typ.)

• Measured by changing the main discharge capacitance

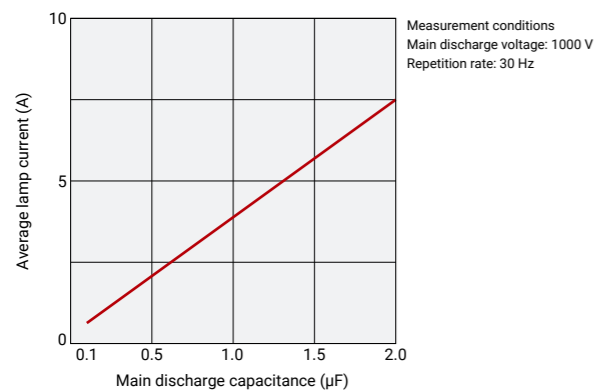

■ Figure 30: Peak lamp current (Typ.)

• Measured by changing the main discharge capacitance

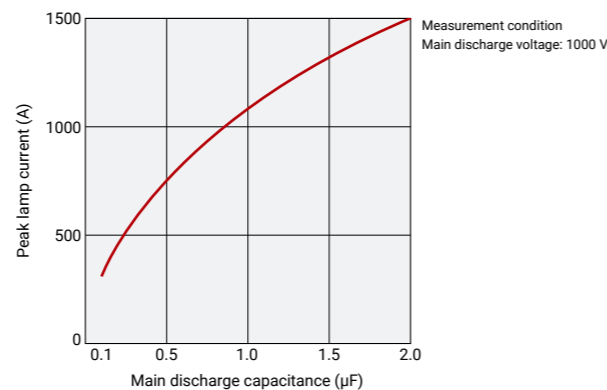

3-8 Light output stability

Light output stability is expressed as the variation in light output intensity per flash, and is defined by the difference (p-p) between the maximum and minimum values relative to the mean value, and also by the coefficient of variation (CV) of the data relative to the mean value.

$$\text{Light output stability (\% CV)} = \text{light output standard deviation} / \text{average light output} \times 100$$

$$\text{Light output stability (\% p-p)} = (\text{maximum light output} - \text{minimum light output}) / \text{average light output} \times 100$$

To measure the light output stability, a sample-and-hold circuit is used to make evaluations in near real-time. Light pulses produced from the xenon flash lamp are input to a photodetector (Si photodiode), and the generated photocurrent is integrated by an operational amplifier. The integrated value is then output as a DC value using the sample-and-hold circuit. Our sample-and-hold circuit timing is set to retain the signal of about 80 % of the peak output, on the falling edge of the flash pulse waveform. Retaining the signal from the falling edge of the flash pulse, instead of the steep rising edge, helps minimize the effects of the xenon flash lamp delay time and jitter time.

■ Figure 31: Measurement setup

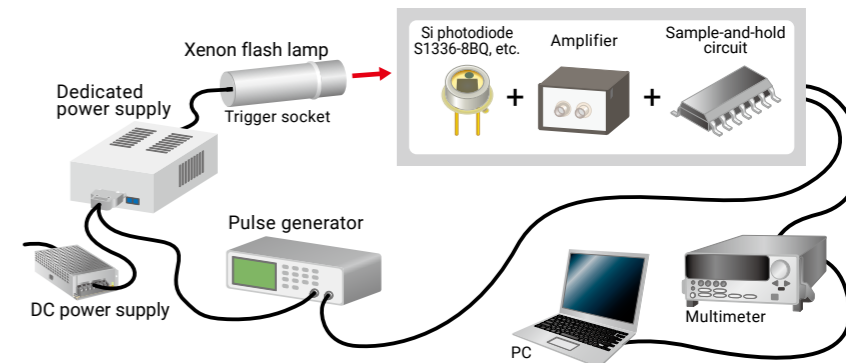

(1) Light output stability during initial lighting

Xenon flash lamps emit a full flash of light immediately after lighting, but the initial stability of the light output differs depending on the product type and operating conditions. In continuous operation, it usually takes a few minutes for the light output to stabilize. This is because the pressure of the filler gas varies with the rise in temperature after lighting. The higher the repetition rate, the longer the time taken to reach the maximum light output. However, xenon flash lamps generate less heat compared to other lamps and so allow reducing the warm-up time (time required to reach stable operation) during initial lighting. When xenon flash lamps are used in intermittent lighting with a short flash duration (so-called burst mode), the light output will not be significantly affected by the temperature during initial lighting even if the repetition rate is high.

■ Figure 32: Light output stability during initial lighting (Typ.)

• 5 W xenon flash lamp module

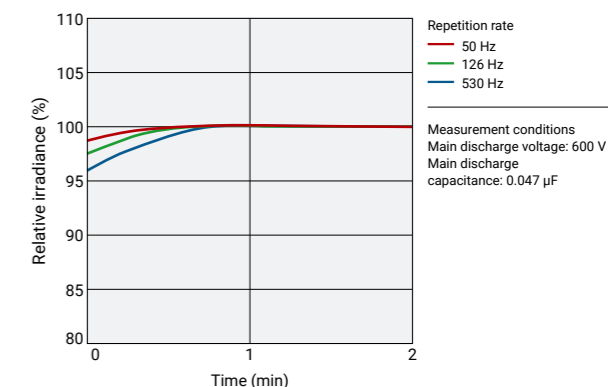

(2) Light output stability vs. ambient temperature

Light output intensity varies with the ambient temperature because the luminous efficiency fluctuates according to the filler gas pressure that varies with the temperature. To obtain stable characteristics, the ambient temperature must be held constant to the greatest extent possible.

■ Figure 33: Light output stability (Typ.)

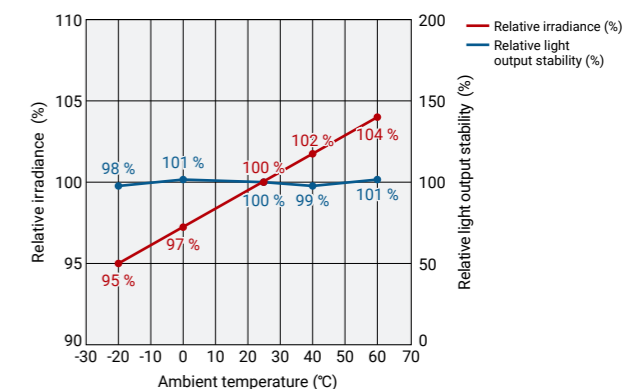

3 Characteristics

(3) Light output stability vs. main discharge voltage

The main discharge voltage affects light output stability. Using a xenon flash lamp outside the recommended main discharge voltage range will worsen the light output stability. Lamps must be used within the recommended main discharge voltage range.

■ Figure 34: Light output stability (Typ.)

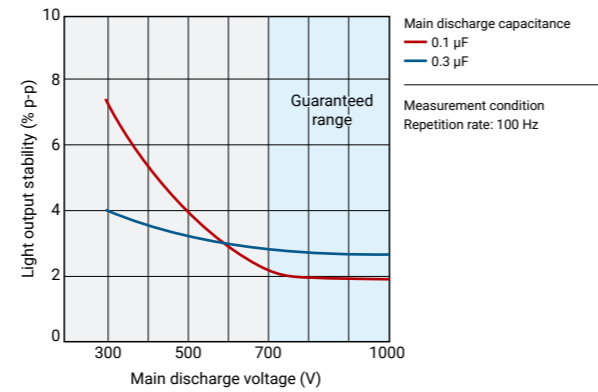

(4) Light output stability vs. trigger energy

Light output stability also depends on the stability of the preliminary discharges. If the trigger energy is too high, the lamp operation becomes unstable. If too low, the lamp may fail to flash. Hamamatsu dedicated power supplies are designed to provide the optimal trigger energy as listed below. To take advantage of the high stability of xenon flash lamps, the trigger energy must be taken into account when designing a power supply system.

■ Table 2: Trigger energy of dedicated power supplies

Maximum average lamp input (continuous) (W)	Trigger voltage (DC) (V)	Trigger capacitance (μF)	Trigger energy (mJ)
10	140	0.22	2.2
15	170	0.22	3.2
20	170	0.22	3.2
60	180	0.22	3.6

(5) Light output stability vs. repetition rate

Higher light output stability can be obtained at a lower repetition rate. However, to ensure operation with high stability and high flash capability, besides supplying the optimal lamp input energy and trigger energy, we recommend operating a lamp at a repetition rate higher than 10 Hz.

The following figures show plots of light output stability versus repetition rate when lamps are operated at their maximum lamp input energy.

■ Light output stability (Typ.)

• Figure 35: 2 W xenon flash lamp module

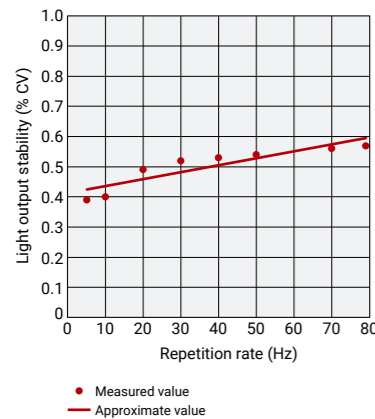

Measurement conditions
Main discharge voltage: 600 V
Main discharge capacitance: 0.141 μF
Detector: Si photodiode S1336-8BQ
(190 nm to 1100 nm)

• Figure 36: 5 W xenon flash lamp module

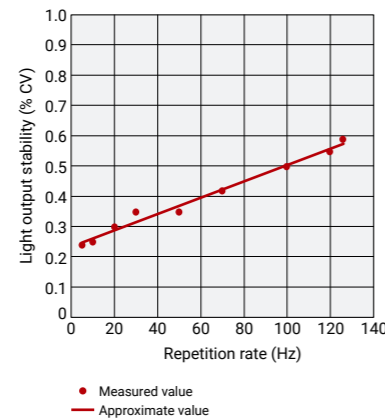

Measurement conditions
Main discharge voltage: 600 V
Main discharge capacitance: 0.22 μF
Detector: Si photodiode S1336-8BQ
(190 nm to 1100 nm)

• Figure 37: 20 W xenon flash lamp module

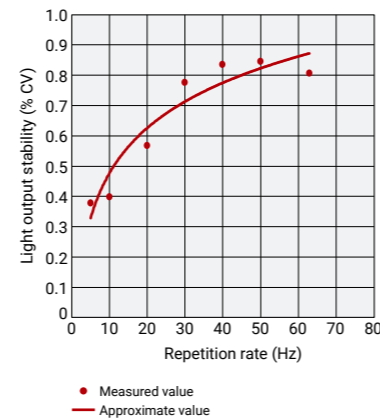

Measurement conditions
Main discharge voltage: 1000 V
Main discharge capacitance: 0.64 μF
Detector: Si photodiode S1336-8BQ
(190 nm to 1100 nm)

• Figure 38: 10 W xenon flash lamp

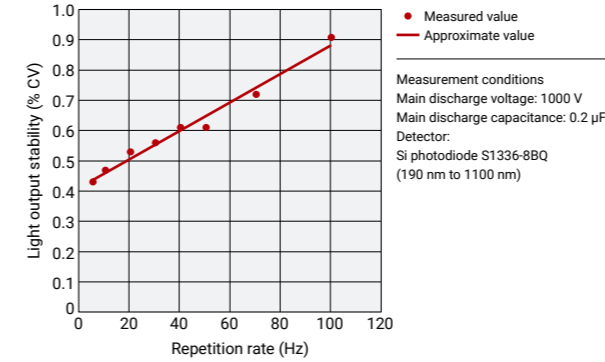

Measurement conditions
Main discharge voltage: 1000 V
Main discharge capacitance: 0.2 μF
Detector: Si photodiode S1336-8BQ
(190 nm to 1100 nm)

• Figure 39: 15 W xenon flash lamp

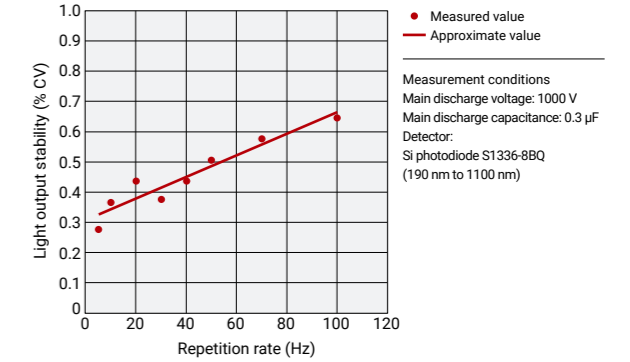

Measurement conditions
Main discharge voltage: 1000 V
Main discharge capacitance: 0.3 μF
Detector: Si photodiode S1336-8BQ
(190 nm to 1100 nm)

• Figure 40: 20 W xenon flash lamp

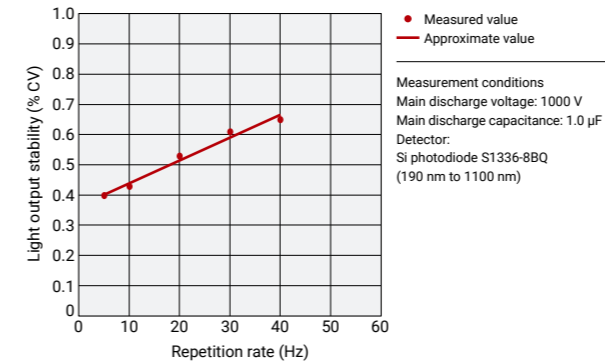

Measurement conditions
Main discharge voltage: 1000 V
Main discharge capacitance: 1.0 μF
Detector: Si photodiode S1336-8BQ
(190 nm to 1100 nm)

• Figure 41: 60 W xenon flash lamp

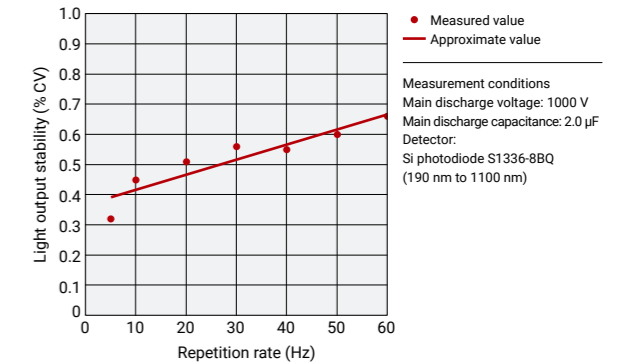

Measurement conditions
Main discharge voltage: 1000 V
Main discharge capacitance: 2.0 μF
Detector: Si photodiode S1336-8BQ
(190 nm to 1100 nm)

(6) Light output stability vs. wavelength

Light output stability per flash shows almost the same pattern at different wavelengths. This feature allows making measurements with a high signal-to-noise ratio in spectrophotometry where two wavelengths are used, one serving as the reference signal and the other as the sample signal.

■ Figure 42: Light output stability (Typ.)

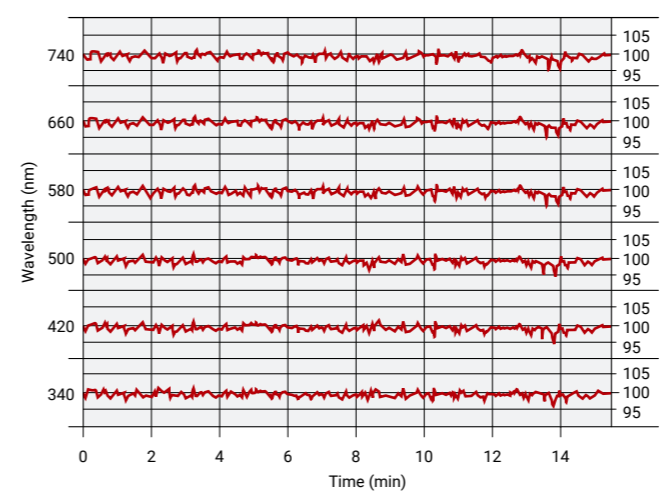

Measurement setup

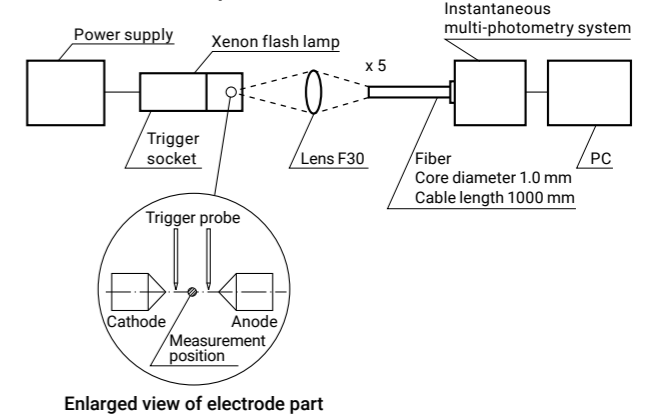

3-9 Approach to stabilizing the light output

Please note the following points to use xenon flash lamps with high light output stability.

(1) Use the light in the center of the arc discharge.

The light output stability of a xenon flash lamp differs depending on the arc discharge measurement position. The closer to the center of the arc discharge, the more stable the light output.

■ Figure 43: Light output stability (Typ.)

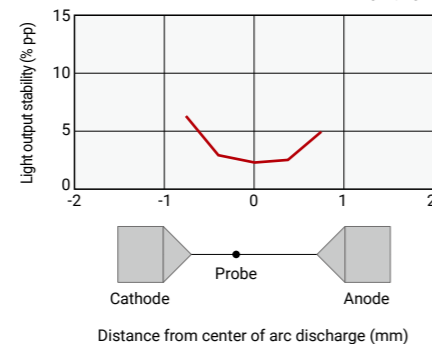

(2) Do not use the light at the initial lighting.

Highly stable output light can be obtained from a xenon flash lamp by avoiding the warm-up time (time taken to reach stable operation) at the initial lighting.

■ Figure 44: Light output stability (Typ.)

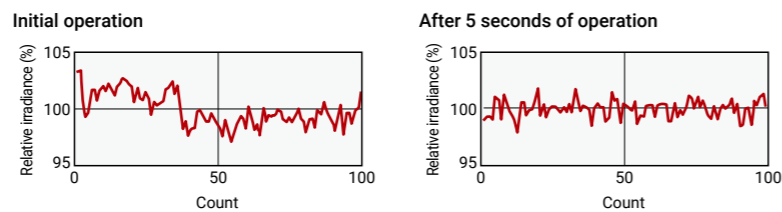

(3) Average the data.

Light output stability is improved by processing and averaging multiple acquired data.

■ Figure 45: Light output stability (Typ.)

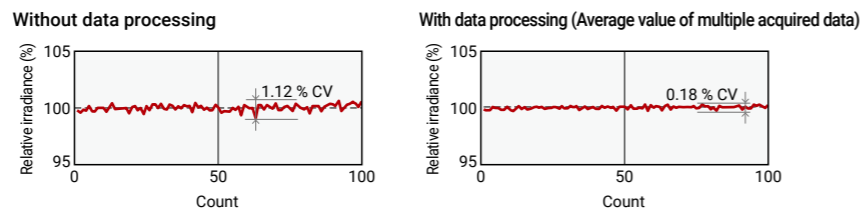

(4) Do not install lamps with the light output window facing downward.

Installing a lamp with its light output window facing downward is not recommended. Debris particles from the inside of the lamp may adhere to the light output window, causing a drop in the light output.

Please note the following points when designing a trigger socket and power supply.

Since the fluctuation of the main discharge voltage adversely affects the light output, use a regulated DC power supply with high stability. After a xenon flash lamp emits a flash, residual ions remain for a certain length of time. For example, when the lamp input energy is 0.05 J, the deionization time for residual ions is approx. 400 μs. This deionization time becomes longer as the lamp input energy is increased. If the lamp is operated at a speed higher than the deionization time, a continuous discharge occurs in the lamp causing unstable operation. Therefore, when setting the charging time for the main discharge capacitor, take the deionization time for residual ions into account according to your operating conditions. Also set the trigger energy to an optimal value that ensures highly stable operation.

The life of xenon flash lamps greatly depends on the lamp input energy (per flash). In general, the higher the lamp input energy (per flash) is, the shorter the life tends to be. The light output at shorter wavelengths is also more likely to decrease.

■ Figure 46: Life characteristics at different lamp input energy (Typ.)

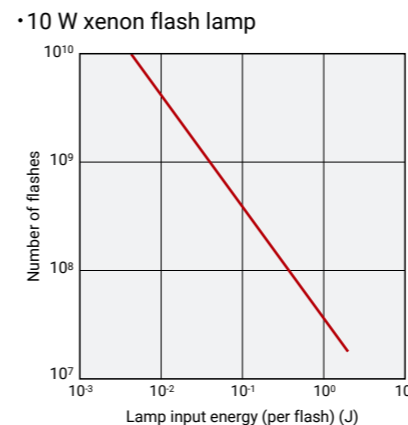

NOTE: The characteristic-guaranteed lamp input energy range for 10 W xenon flash lamps is 0.01 J to 0.1 J.

■ Figure 47: Life characteristics at different wavelengths (Typ.)

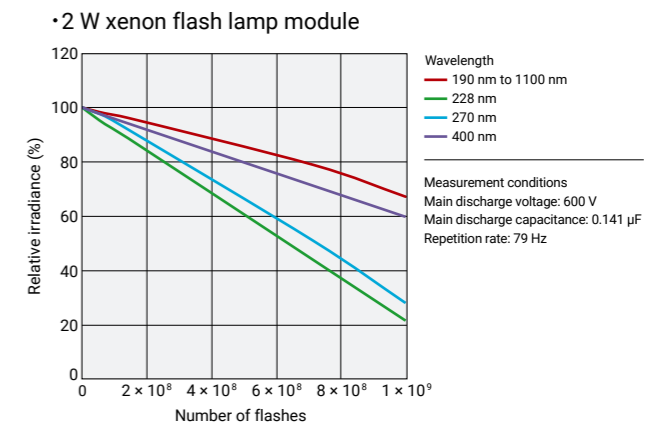

The guaranteed life differs depending on each product type. The guaranteed life is defined as the time at which the light output in a spectral range of 190 nm to 1100 nm drops below 50 % of its initial level, or the light output fluctuation exceeds the maximum specification when operated under the specified conditions.

■ Figure 48: Light output stability (Typ.)

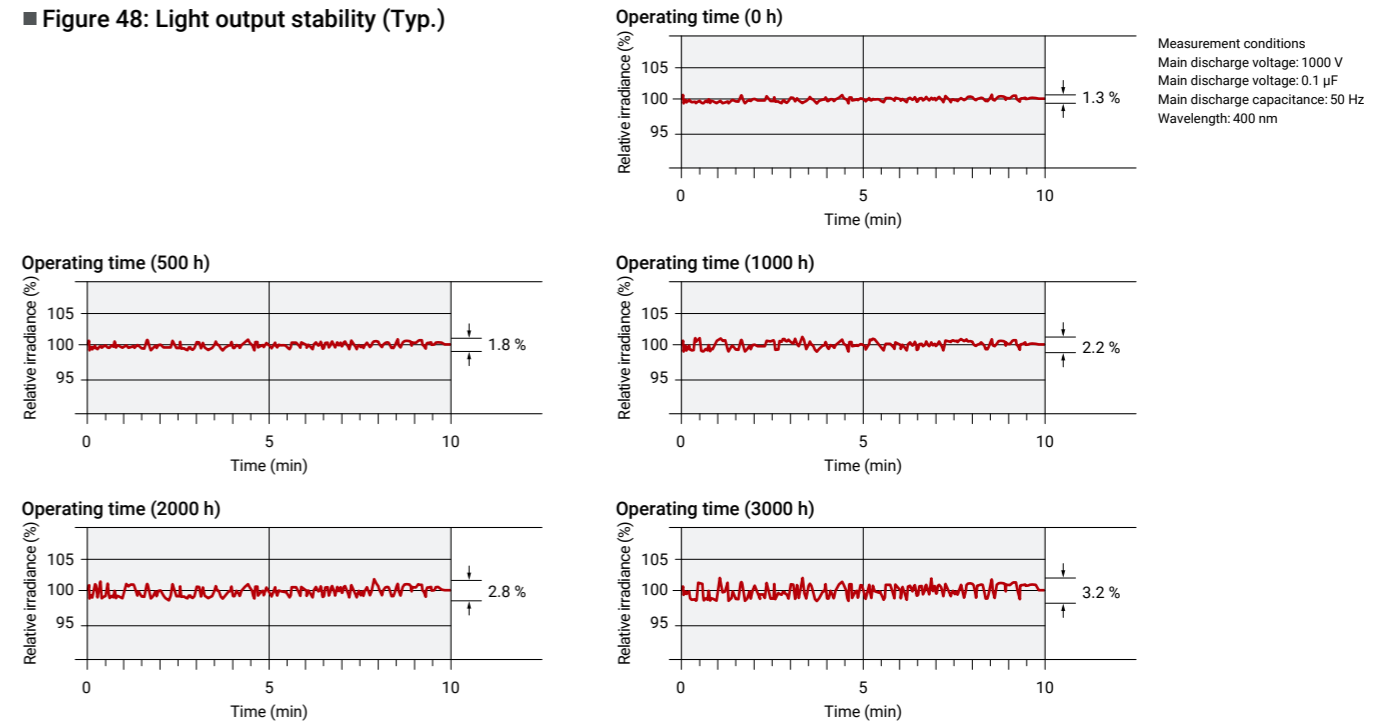

5 Electromagnetic noise

Xenon flash lamps require a trigger voltage supply of between 5 kV p-p to 7 kV p-p for every flash. Moreover, when the main discharge occurs, an instantaneous current of several hundred amperes flows, which generates electromagnetic noise.

If taking measures for electromagnetic noise is inadequate, for example, if the trigger RTN. and DC power supply GND. are electrically conductive via the enclosure or other parts, then electromagnetic noise propagates to the trigger RTN. through the enclosure and common GND. This prevents the xenon flash lamp power supply from detecting correct pulse waveforms, causing the lamp to fail to flash. As an electromagnetic noise countermeasure, you can move the common GND. away from the noise source to minimize propagation of electromagnetic noise to the trigger RTN. Hamamatsu xenon flash lamp power supplies utilize a photocoupler that isolates the trigger RTN. from the DC power supply GND. to prevent electromagnetic noise from propagating to the trigger RTN.

■ Figure 49: Trigger waveform (Typ.)

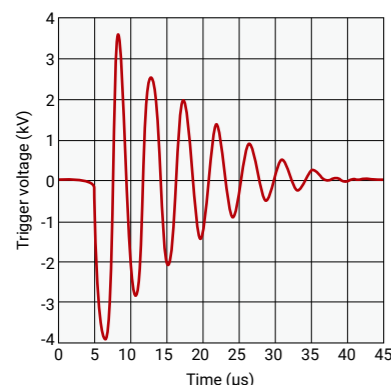

■ Figure 50: Countermeasures for GND. electromagnetic noise

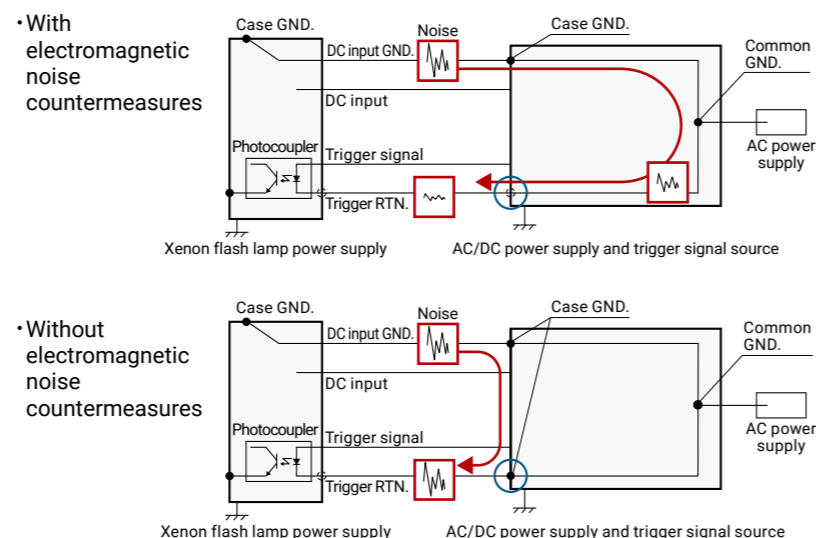

Taking the following countermeasures for electromagnetic noise is advisable to avoid possible effects on the peripheral devices.

- (1) Place the lamp and trigger socket in a metal shielded box.
- (2) Use a trigger socket with a shielded cable.
- (3) Be sure to connect GND. to the enclosure of the power supply and lamp module.
At this point, make a GND. connection that is separate from the photosensor GND.
- (4) Use properly shielded cables for input to the power supply and lamp module.
For example, when using a D-sub connector, make sure that the shield wire of the input cable is securely in contact with the connector hood by wrapping conductive metal tape around the shield wire.

■ Example of connecting the 20 W xenon flash lamp GND. terminal to the power supply

Connect the GND. ring terminal to the GND. terminal screw on the power supply enclosure.



■ Shielding example of D-sub input connector cable

Make sure that the shield wire is securely in contact with the connector hood by wrapping conductive metal tape around the shield wire.

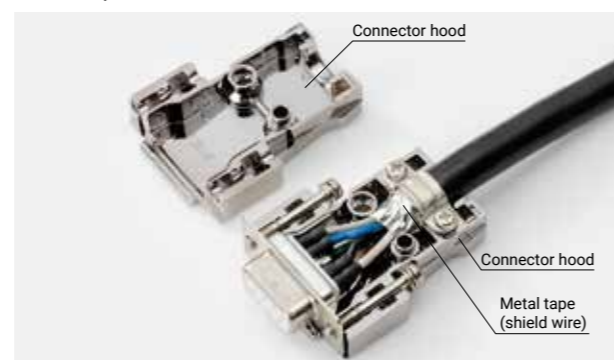

6 Trigger sockets

6-1 Structure

A trigger socket is required to operate a xenon flash lamp. The trigger socket is made up of a high-voltage generation transformer (trigger transformer), voltage-dividing resistors, bypass capacitors, and a diode. Our xenon flash lamp modules include the same circuit configuration as the trigger socket.

■ Figure 51: Circuit configuration example (For lamps with one probe)

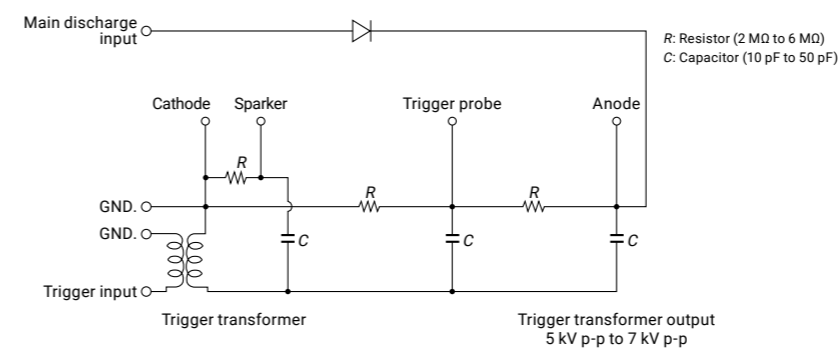

6-2 Operation

When a pulse voltage of 100 V to 300 V (less than 2.8 mJ) is applied to the primary side of the trigger transformer, a high voltage pulse of 5 kV p-p to 7 kV p-p is generated at the secondary side. This generated pulse voltage is then applied to the sparker and each trigger probe electrode through the bypass capacitors, forming a preliminary discharge. The main discharge is then generated between the cathode and anode with the specified voltage applied. The voltage-dividing resistors and bypass capacitors in the trigger socket are selected to ensure stable lamp operation. The diode at the main discharge side acts to shape waveforms as well as to prevent the trigger energy from leaking to the main discharge capacitor, thus allowing stable operation even at low voltages.

The cable length of the trigger socket affects the flash pulse width (flash duration), lamp input current, and trigger energy. The longer the cable length, the wider the flash pulse width and the lower the lamp input current and trigger energy tend to be, thus increasing the possibility that the lamp may fail to flash. In contrast, the shorter the cable length, the shorter the flash pulse width and the higher the lamp input current tends to be. This state may therefore cause continuous lighting or intermittent lighting, leading to a reduced xenon flash lamp life. Our trigger sockets are delivered with an optimal cable length, so we recommend using them without changing the cable length. When connecting a xenon flash lamp to the output side (voltage-dividing resistors and bypass capacitors) of the trigger socket, do not use a cable but instead connect the lamp directly to the trigger socket. If a cable is used to connect between the lamp and the trigger socket, the trigger energy from the trigger socket will be smaller, increasing the possibility that the lamp may fail to flash.

7 Power supplies

Xenon flash power supplies consist of a main discharge power supply and a trigger power supply.

7-1 Main discharge power supply

The main power supply provides energy to the xenon flash lamp. Since the light output is nearly proportional to the lamp input energy, a regulated high-voltage DC power supply and a high-quality main discharge capacitor are required.

7-2 Trigger power supply

In order for a xenon flash lamp to operate stably, the preliminary discharge must be stable. The trigger power supply is used to produce preliminary discharges and consists of a power supply for feeding power to the trigger transformer and a control circuit that is made up of a switching element (thyristor) and a trigger capacitor for supplying trigger energy. When a trigger signal is input to the gate of the thyristor, the charge stored in the trigger capacitor is released as trigger energy which is then input to the primary side of the trigger transformer.

7-3 Power supply design precautions

After a xenon flash lamp emits a flash, residual ions remain for a certain length of time. The deionization time for residual ions differs depending on the filler gas pressure, main discharge voltage, main discharge capacitance, and arc size. The larger the light output is, the longer the deionization time will be. For example, when a lamp with an arc size of 1.5 mm is operated with a main discharge voltage of 1000 V and a main discharge capacitance of 0.1 μF , then the deionization time will be approx. 400 μs . If the main discharge capacitor is charged with the main discharge voltage supplied from the main discharge power supply at a speed higher than the deionization time, a continuous discharge occurs in the lamp regardless of whether the trigger is input or not, resulting in unstable operation. Therefore, when designing power supplies, please take measures to avoid the effects from residual ions.

(1) Rapid-charging power supply (Hamamatsu circuit system)

This power supply charges the main discharge capacitor quickly and at a constant current. Once the lamp lights up, the charging circuit is forcibly isolated for a certain time (dead time) until the residual ions disappear. This circuit is complex, but unlike CR charging power supplies, does not require a current-limiting series resistor and so offers features such as reduced power loss and operation at a high repetition rate.

■ Figure 52: Circuit configuration example

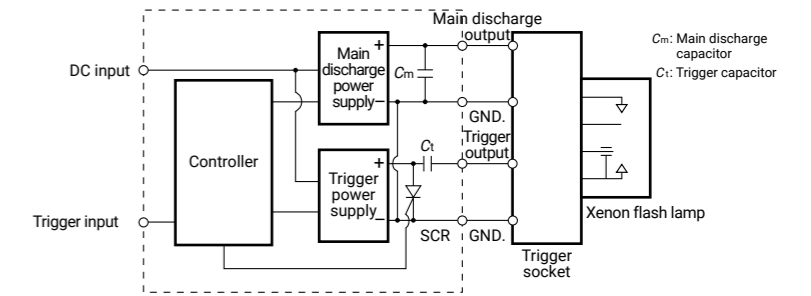

■ Figure 53: Charging waveform for main discharge capacitor

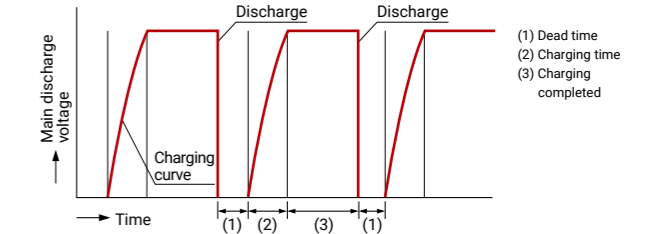

(2) CR charging power supply

This power supply charges the main discharge capacitor from a high-voltage DC power supply through a current-limiting series resistor. The CR time constant is utilized to avoid effects from residual ions until these disappear after the lamp emits a flash. The circuit is simple, but the lamp cannot be operated at a high repetition rate due to high resistance loss. When using this circuit, the charging characteristics of the main discharge capacitor and resistor must be taken into account.

■ Figure 54: Circuit configuration example

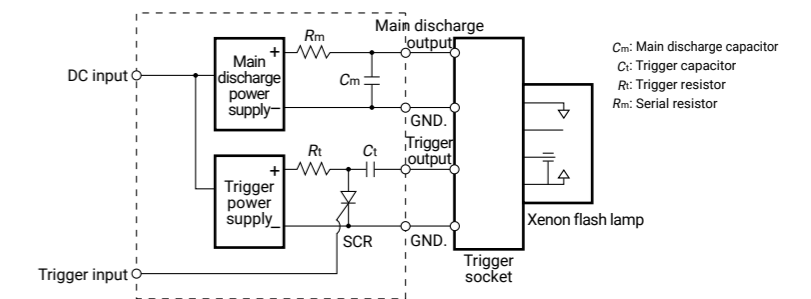

■ Figure 55: Charging waveform for main discharge capacitor

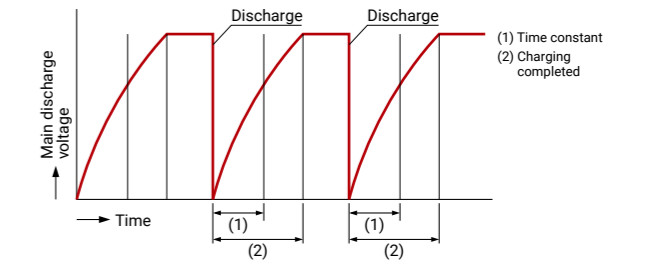

8 Applications

8-1 Water quality analysis

Pollution of water such as in rivers, oceans, and groundwater causes environmental degradation and health hazards. There are a huge number of substances that can contaminate water, so standard values and measurement methods for the main pollutants in water are prescribed by laws and regulations. Water quality analysis involves several criteria or indicators and measurement techniques. The broad spectrum of xenon flash lamps is utilized to measure the total phosphorus, total nitrogen and other chemical parameters by absorption and fluorescence spectroscopy using UV light.

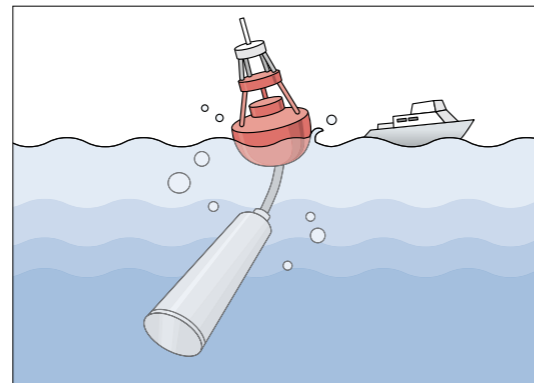

8-2 Atmospheric analysis and gas analysis

Optical techniques for atmospheric analysis and gas analysis make use of UV light or infrared light. Gas molecules absorb light at specific wavelengths, so the concentration of a gas can be calculated by measuring its absorbance of light. Xenon flash lamps are ideal for measuring hazardous gases emitted from factory chimneys and for monitoring atmospheric air pollution levels since those applications require a long-life light source needing less maintenance. Other features of xenon flash lamps include stable emission of light that provides measurements with a high signal-to-noise ratio.

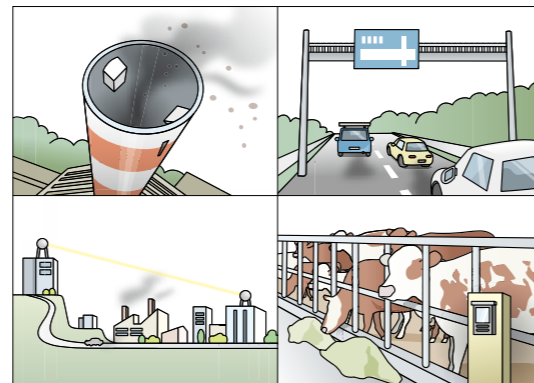

8-3 Mineral and gemstone inspection

Mineral/gemological inspection uses UV light as the excitation light, and the fluorescence or phosphorescence images and spectra are measured to distinguish between natural and artificial materials. The excitation light source must provide high power to efficiently produce fluorescence or phosphorescence which is usually very weak. Using xenon flash lamps as the excitation light source will deliver high throughput.



8-4 Color analysis

People perceive light as colors, and each color consists of a specific wavelength. Colorimetry is a useful tool for analyzing and quantifying the color of light by measuring the light intensity at a specific wavelength. Xenon flash lamps with a broad spectrum are widely used in this application to evaluate the quality of various materials such as printed matter, LED displays, foods, pharmaceuticals, films, and optical filters.

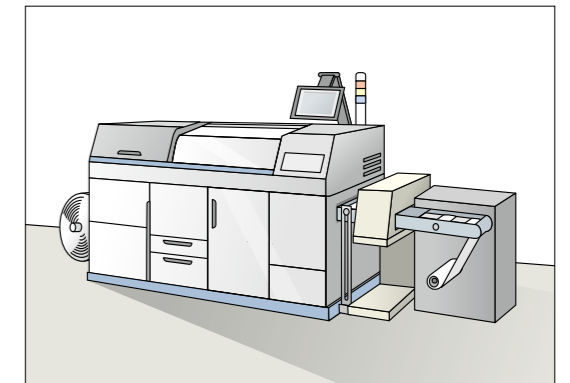

8-5 Semiconductor inspection and process control

Semiconductor manufacturing equipment takes advantage of the high light output of xenon flash lamps such as for wafer defect inspection and endpoint monitoring.

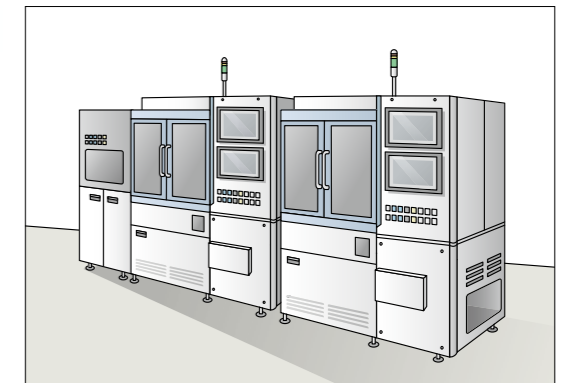

8-6 Food inspection

In food inspection, a variety of components and substances such as sugar content, moisture content and foreign matter must be measured to determine the food quality. Xenon flash lamps have a broad spectrum up to the mid-infrared region and generate less heat, making them ideal for determining the quality of food samples without damaging them. Xenon flash lamps are expected to be used for on-site, real-time measurements in future smart agriculture.

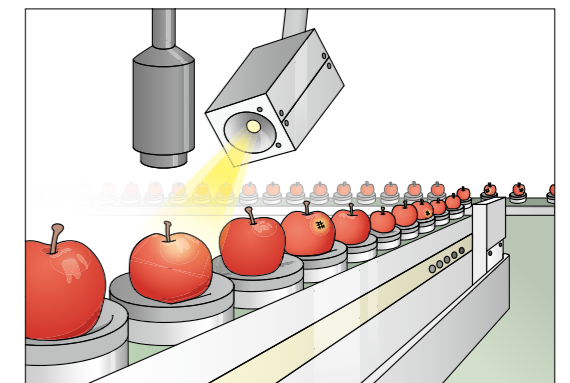

Water quality analysis

Atmospheric analysis and gas analysis

Gas analysis

Gas analysis

Mineral and gemstone inspection

Color analysis

Semiconductor inspection and process control

Food inspection

8 Applications

8-7 In vitro diagnostics (Blood and urine)

In vitro diagnostics that quantitatively measures the components of blood and urine (protein, sugar, oxygen, etc.) is a versatile tool for disease diagnosis and treatment decisions. A measurement method using light absorbance is widely used for in vitro diagnostics. Xenon flash lamps are compact, yet emit a broad spectrum of light that covers the entire wavelength range with a single lamp. This makes it possible to incorporate a lamp into portable analytical instruments, contributing to POCT (point-of-care testing). Xenon flash lamps also generate low heat to provide accurate measurements without thermal effects on the reagents.

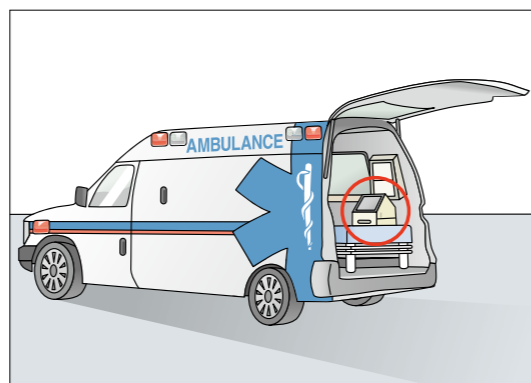

8-10 MTP reader

MTP readers are designed to measure absorbance, fluorescence and luminescence spectra of a large number of samples in a microtiter plate, so the high light output of xenon flash lamps is a real advantage in making rapid and accurate measurements. Since thermal effects on the samples under test should be avoided, xenon flash lamps that generate less heat are also a good choice for MTP readers.

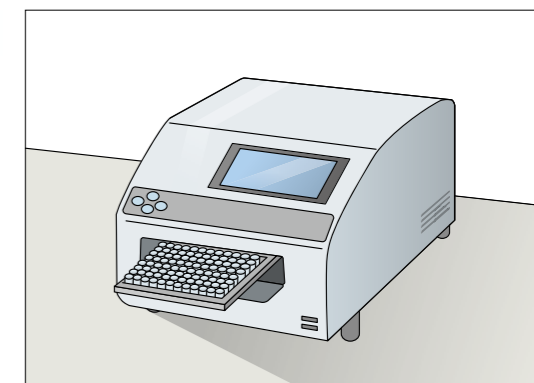

8-8 UV to visible spectrophotometry

UV-visible spectrophotometry enables both quantitative and qualitative analysis of a sample by measuring the absorption, transmission, and reflection spectra of the sample. The broad spectrum of xenon flash lamps allows a single lamp to cover the entire UV-to-visible range.

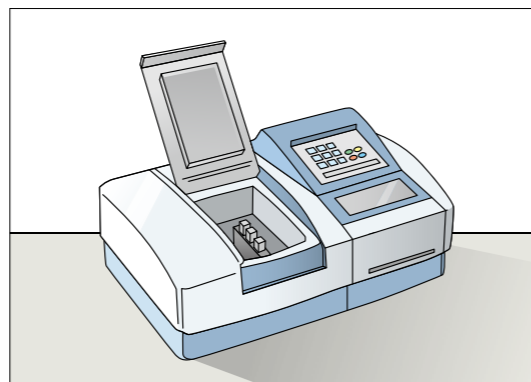

8-11 Imaging flow cytometry

Flow cytometry is a technique for analyzing the properties and structure of cells by irradiating a laser beam onto the cells entrained in the fluid flowing rapidly through a flow cell and measuring their scattered light and fluorescence spectra. Imaging flow cytometry combines this flow cytometry with a cell image diagnosis function and utilizes xenon flash lamps to accurately capture images of cells flowing at high speed.

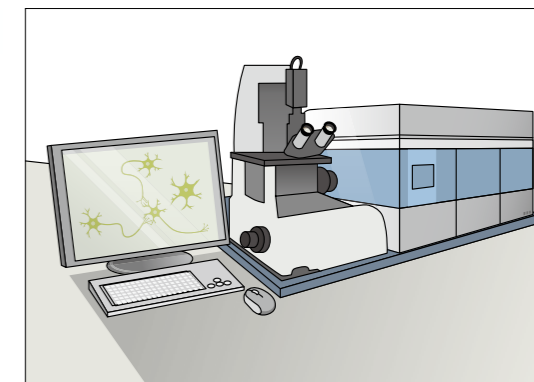

8-9 High-performance liquid chromatography (HPLC)

In high-performance liquid chromatography (HPLC), the solvent used to separate the components in a liquid sample is called the mobile phase. The mobile phase is delivered by a pump at a constant flow rate from the column (stationary phase) to the detector. The components contained in the liquid sample are separated in the column, and the absorption or fluorescence spectra are measured with the detector placed at the exit of the column to quantify and identify each component. Xenon flash lamps are ideal for fluorescence measurement that requires high intensity of light.

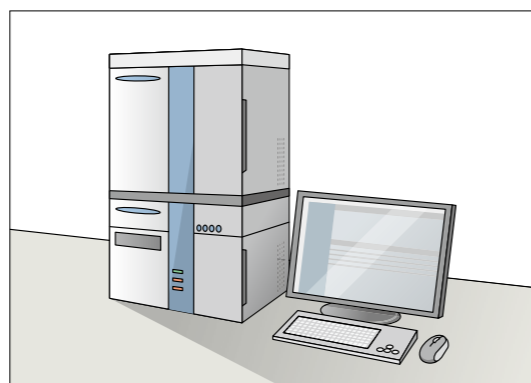

In vitro diagnostics (Blood and urine)

UV to visible spectrophotometry

High-performance liquid chromatography (HPLC)

MTP reader

Imaging flow cytometry

Main Products

Opto-semiconductors

- Si photodiodes
- APD
- MPPC®
- Photo IC
- Image sensors
- PSD
- Infrared detectors
- LED
- Optical communication devices
- Automotive devices
- X-ray flat panel sensors
- MEMS devices
- Mini-spectrometers
- Opto-semiconductor modules

Electron Tubes

- Photomultiplier tubes
- Photomultiplier tube modules
- Microchannel plates
- Image intensifiers
- Xenon lamps / Mercury-xenon lamps
- Deuterium lamps
- Light source applied products
- Laser applied products
- Microfocus X-ray sources
- X-ray imaging devices

Imaging and Processing Systems

- Scientific cameras
- Spectroscopic and optical measurement systems
- Ultrafast photometry systems
- Life science systems
- Medical systems
- Non-destructive inspection products
- Semiconductor manufacturing support systems
- Material research systems

Laser Products

- Single chip laser diodes
- Laser diode bar modules
- Quantum cascade lasers
- Applied products of semiconductor lasers
- Solid state lasers
- Laser related products

Sales Offices

Japan:
HAMAMATSU PHOTONICS K.K.
325-6, Sunayama-cho, Naka-ku,
Hamamatsu City, Shizuoka Pref. 430-8587, Japan
Telephone: (81)53-452-2141, Fax: (81)53-456-7889
E-mail: intl-div@hq.hpk.co.jp

China:
HAMAMATSU PHOTONICS (CHINA) CO., LTD.
Main Office
1201 Tower B, Jiaming Center, 27 Dongsanhuan Beilu,
Chaoyang District, 100020 Beijing, P.R. China
Telephone: (86)10-6586-6006, Fax: (86)10-6586-2866
E-mail: hpc@hamamatsu.com.cn

Shanghai Branch
4905 Wheelock Square, 1717 Nanjing Road West,
Jingan District, 200040 Shanghai, P.R. China
Telephone: (86)21-6089-7018, Fax: (86)21-6089-7017
E-mail: hpcsh@hamamatsu.com.cn

Shenzhen Branch
14F China Merchants Tower 1#, No. 1166 Wanghai Road,
Shekou, Nanshan District, Shenzhen, P.R. China
Telephone: (86)755-2165-9058, Fax: (86)755-2165-9056
E-mail: hpcsz@hamamatsu.com.cn

Wuhan Branch
Room 1005 Fanyue City T2 Building, No. 19 Guanshan
Avenue, East Lake High-tech District, Hubei, P.R. China
Telephone: (86)27-5953-8219
E-mail: hpcwh@hamamatsu.com.cn

Taiwan:
HAMAMATSU PHOTONICS TAIWAN CO., LTD.
Main Office
8F-3, No.158, Section 2, Gongdao 5th Road,
East District, Hsinchu, 300, Taiwan R.O.C.
Telephone: (886)3-659-0080, Fax: (886)3-659-0081
E-mail: info@hamamatsu.com.tw

U.S.A.:
HAMAMATSU CORPORATION
Main Office
360 Foothill Road, Bridgewater, NJ 08807, U.S.A.
Telephone: (1)908-231-0960, Fax: (1)908-231-1218

California Office
2875 Moorpark Ave., San Jose, CA 95128, U.S.A.
Telephone: (1)408-261-2022, Fax: (1)408-261-2522

Germany, The Netherlands, Poland, Denmark, Israel:
HAMAMATSU PHOTONICS DEUTSCHLAND GMBH
Main Office
Arzbergerstr. 10, 82211 Herrsching am Ammersee,
Germany
Telephone: (49)8152-375-0, Fax: (49)8152-265-8
E-mail: info@hamamatsu.de

Netherlands Office
Transistorstraat 7, 1322 CJ Almere, The Netherlands
Telephone: (31)36-5405384, Fax: (31)36-5244948
E-mail: info@hamamatsu.nl

Poland Office
10 Ciolka Street, 126-127 01-402 Warsaw, Poland
Telephone: (48)22-646-0016, Fax: (48)22-646-0018
E-mail: poland@hamamatsu.de

Danish Office
Lautruphøj 1-3, 2750 Ballerup, Denmark
Telephone: (45)44-20-99-49, Fax: (45)44-20-99-10
Email: info@hamamatsu.dk

Israel Office (HAMAMATSU PHOTONICS ISRAEL LTD.)
Ha-Menofim 10 st., third floor, 4672561 Herzliya, Israel
E-mail: Info@hamamatsu.co.il

France, Switzerland, Belgium, Spain:
HAMAMATSU PHOTONICS FRANCE S.A.R.L.
Main Office
19 Rue du Saule Trapu, Parc du Moulin de Massy,
91882 Massy Cedex, France
Telephone: (33)1 69 53 71 00, Fax: (33)1 69 53 71 10
E-mail: infos@hamamatsu.fr

Swiss Office
Dornacherplatz 7, 4500 Solothurn, Switzerland
Telephone: (41)32-625-60-60, Fax: (41)32-625-60-61
E-mail: swiss@hamamatsu.ch

Belgian Office
Axisparc Technology, Rue André Dumont 7
1435 Mont-Saint-Guibert, Belgium
Telephone: (32)10 45 63 34, Fax: (32)10 45 63 67
E-mail: info@hamamatsu.be

Spanish Office
C. Argenters 4, edif 2, Parque Tecnológico del Vallés
08290 Cerdanyola (Barcelona), Spain
Telephone: (34)93 582 44 30
E-mail: infospain@hamamatsu.es

North Europe and CIS:
HAMAMATSU PHOTONICS NORDEN AB
Main Office
Torshamnsgatan 35 16440 Kista, Sweden
Telephone: (46)8-509 031 00, Fax: (46)8-509 031 01
E-mail: info@hamamatsu.se

Russian Office
11, Christoprudny Boulevard, Building 1, Office 114,
101000, Moscow, Russia
Telephone: (7)495 258 85 18, Fax: (7)495 258 85 19
E-mail: info@hamamatsu.ru

Italy:
HAMAMATSU PHOTONICS ITALIA S.R.L.
Main Office
Strada della Moia, 1 int. 6, 20044 Arese (Milano), Italy
Telephone: (39)02-93 58 17 33, Fax: (39)02-93 58 17 41
E-mail: info@hamamatsu.it

Rome Office
Viale Cesare Pavese, 435, 00144 Roma, Italy
Telephone: (39)06-50 51 34 54
E-mail: inforoma@hamamatsu.it

United Kingdom:
HAMAMATSU PHOTONICS UK LIMITED
Main Office
2 Howard Court, 10 Tewin Road, Welwyn Garden City,
Hertfordshire, AL7 1BW, UK
Telephone: (44)1707-294888, Fax: (44)1707-325777
E-mail: info@hamamatsu.co.uk

South Africa Contact:
9 Beukes Avenue, Highway Gardens, Edenvale
1609 South Africa
Telephone/Fax: (27)11-609-0367

- The information in this document is intended to describe the product operation and characteristics and does not constitute a guarantee of the products.
- Information in this catalog is believed to be reliable. However, no responsibility is assumed for possible inaccuracies or omission. Specifications are subject to change without notice. No patent rights are granted to any of the circuits described herein. © 2022 Hamamatsu Photonics K.K.
- Please thoroughly read the precautions and the prohibited uses included in the user manual before installation and use.

Electron Tube Division, HAMAMATSU PHOTONICS K.K.

314-5, Shimokanzo, Iwata City, Shizuoka Pref., 438-0193, Japan
Telephone: (81)539/62-5248, Fax: (81)539/62-2205
www.hamamatsu.com